

Teratai

Produktdaten

Product information
Information produits

Bretz
True Characters

Collection **Teratai**



G 106 Teratai ▶ 306 cm ▼ 181 cm ▲ 80 cm
Stoff · Fabric · Tissu **66 8430**

Treiben lassen



Wie harmonisch Teratai wirkt, wenn sie dahingleitet und sich entfaltet wie ein Seerosenblatt. Dieser organischen Perfektion gehen viel Handarbeit und Geduld voraus: Um den ambitionierten Schnitt zu realisieren – sanft eingezogen, mal über Kante, mal gerundet, glatt, aber nicht zu straff – fordert jede Stoffraute besondere Zuwendung. Die Nähte durchziehen das Sofa wie Blattadern, hauchen dem Naturphänomen Leben ein und versehen es mit Volumen und Struktur. 22 Stunden beansprucht die sensible Wohn-Skulptur, bis sie vollendet im Raum kein Wässerchen trübt. Der dazugehörige Drehsessel lädt zum Verweilen in seiner sicheren Mitte ein.

Collection **Teratai**



G 106 Teratai ▶ 306 cm ▼ 181 cm ▲ 80 cm
Stoff · Fabric · Tissu **66 8430**

Drift and dream

How harmonic Teratai seems to be, as it is drifting and unfolding like a water lily. This organic perfection is the result of a lot of handiwork and patience: In order to realize the ambitious cut – softly indented, sometimes over an edge, rounded here, smooth there but not too tight – every single piece of cloth needs a lot of care. The seams traverse through the sofa like veins through a leaf. They give life to that natural phenomenon and give it volume and structure. 22 hours is how long it takes to shape this sensitive furniture sculpture, until it is ready. The accompanying swivel chair invites you to linger in its safe middle.



G 106 Teratai ▶ 306 cm ▼ 181 cm ▲ 80 cm
Stoff · Fabric · Tissu **66 8430**

Collection **Teratai**



A 106 Teratai ▶ 105 cm ▼ 93 cm ▲ 78 cm
Stoff · Fabric · Tissu **66 8430**



C 106 Teratai Ø 66 cm ▲ 38 cm
Stoff · Fabric · Tissu **66 8430**

Se laisser dériver

Teratai est particulièrement harmonieux lorsqu'il se laisse dériver et se déploie comme une feuille de lotus. Cette perfection organique implique beaucoup de travail manuel et de patience. Pour réaliser la coupe ambitieuse (doucement recouverte, parfois sur l'arête, parfois arrondie, lisse, mais pas trop tendue) chaque losange de tissu a nécessité beaucoup de travail. Les coutures parcourent le canapé comme les veines d'une feuille, conférant un souffle de vie au phénomène naturel en lui apportant volume et structure. La sculpture d'habitation sensible nécessite 22 heures jusqu'à ce qu'elle ne trouble plus l'espace. Le fauteuil rotatif invite à s'y prélasser dans son centre.



H 106 li Teratai ▶ 299 cm ▼ 190 cm ▲ 80 cm
Stoff · Fabric · Tissu **66 8430**

Collection **Teratai**



Z 106 li Teratai ▶ 312 cm ▼ 190 cm ▲ 80 cm
Stoff · Fabric · Tissu **64 1978**



Facts & Highlights

- Die persönliche Oase für Zuhause mit ikonischer Formensprache
- Gerade Elemente können problemlos mit organischen Elementen kombiniert werden
- Für mehr Komfort: Hoher Rücken mit integrierter Nierenstütze
- Bretz-Handarbeit für beste Qualität: Aufwendig im Quiltingverfahren verarbeiteter Bezug
- Sanfte Plastizität durch leichte, punktuelle Einzüge im Sitz

- A personal oasis for the home in an iconic style
- Straight elements can easily be combined with more organically shaped ones
- For more comfort: high back with an integrated kidney support
- Bretz handcraft stands for great quality: an elaborate quilted cover
- Soft plasticity due to point by point indentations in the seat

- L'oasis personnelle pour le domicile, avec un style emblématique
- Les éléments droits peuvent être combinés sans problème aux éléments organiques
- Pour plus de confort : dossier plus haut avec support lombaire intégré
- L'artisanat Bretz garantit la meilleure qualité : housse en contrepointe de qualité supérieure
- Plasticité souple grâce à des inserts ponctuels dans l'assise

Collection **Teratai**



Collection **Teratai**



F 106 Teratai ▶ 256 cm ▼ 134 cm ▲ 80 cm
Stoff · Fabric · Tissu **66 8480**



C 106 Teratai Ø 66 cm ▲ 38 cm
Stoff · Fabric · Tissu **66 8480**



A 106 Teratai ▶ 105 cm ▼ 93 cm ▲ 78 cm
Stoff · Fabric · Tissu **66 8480**



G 106 Teratai ▶ 306 cm ▼ 181 cm ▲ 80 cm
Stoff · Fabric · Tissu **66 8480**

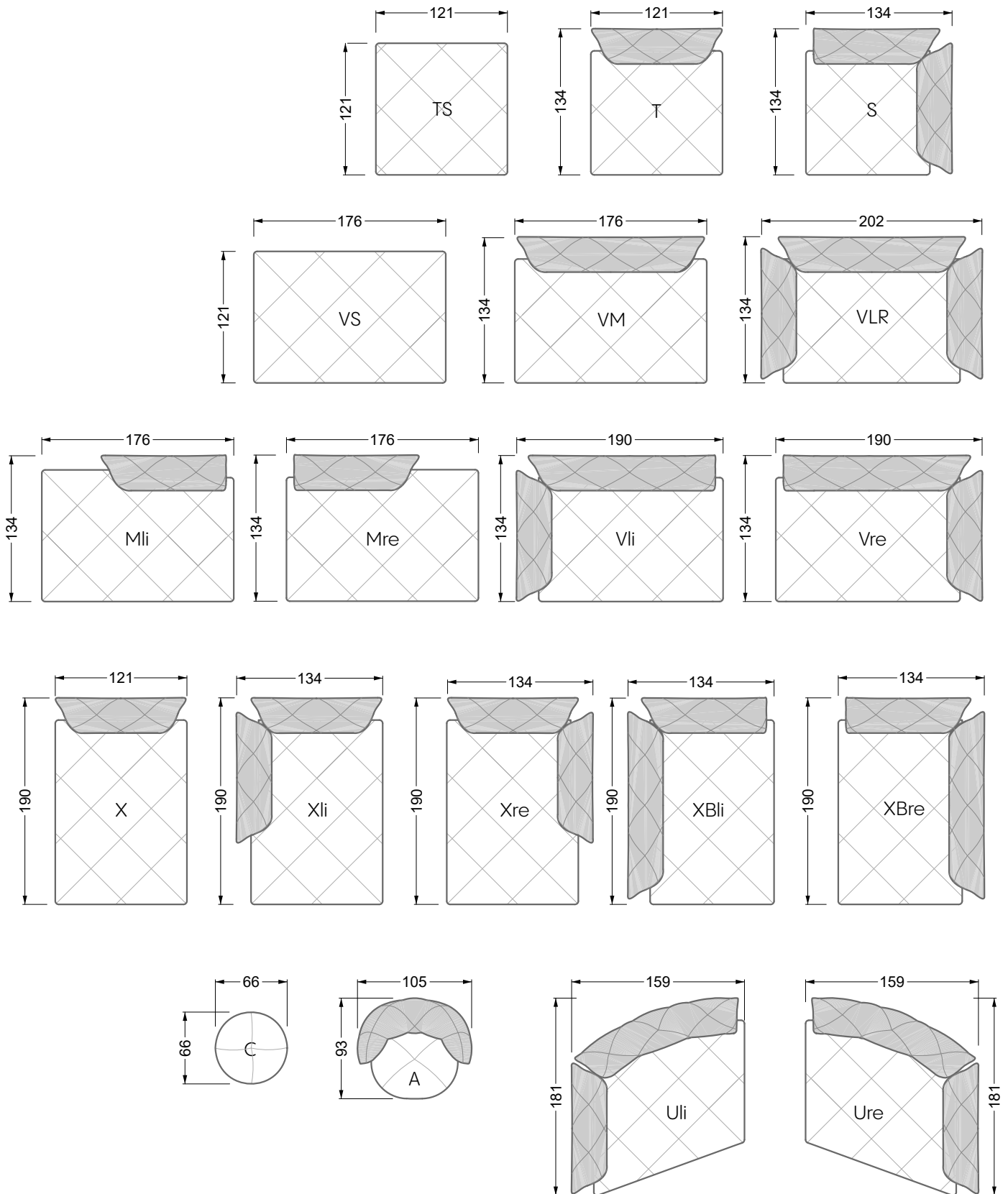

Die Maße gelten für freistehende Einzelteile.

Die Anbauteile weisen an den Anstellseiten eine unecht bezogene Anstellseite ohne Rundung auf.

Die Abschluss- und Einzelteile weisen an den freien Seiten eine Rundung auf (6 cm).

D.h. Bei freier Kombination aus Einzelteilen müssen jeweils 6 cm an den Anstellseiten abgezogen werden.

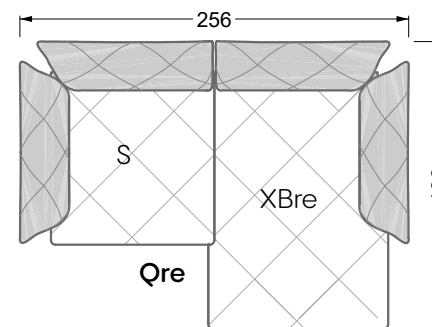
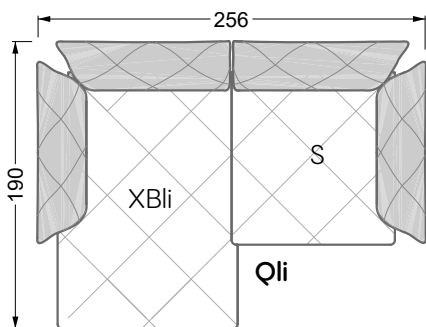
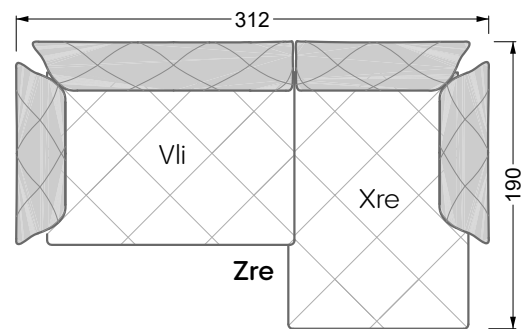
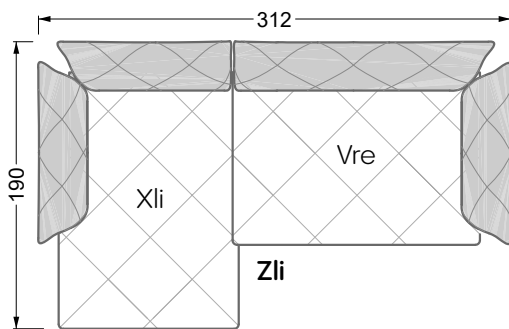
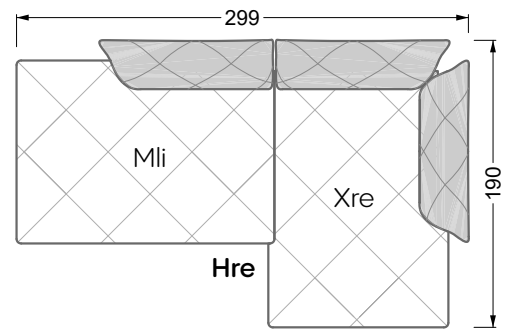
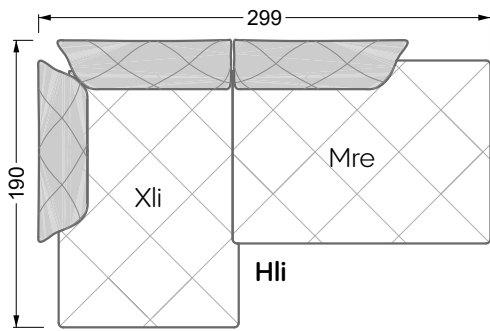
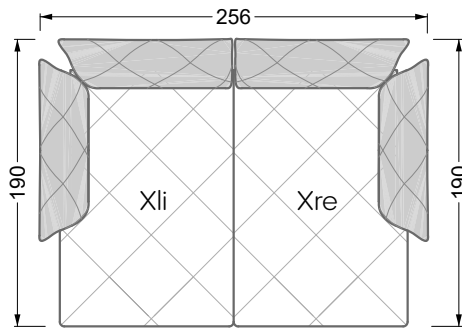
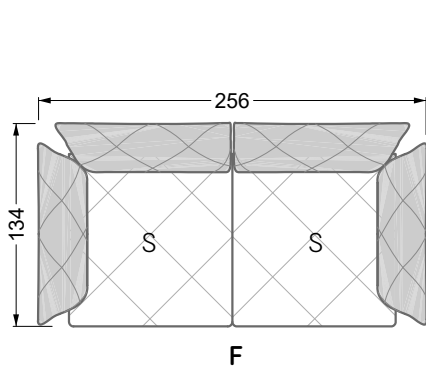
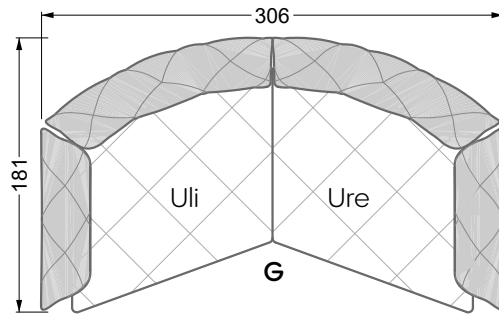

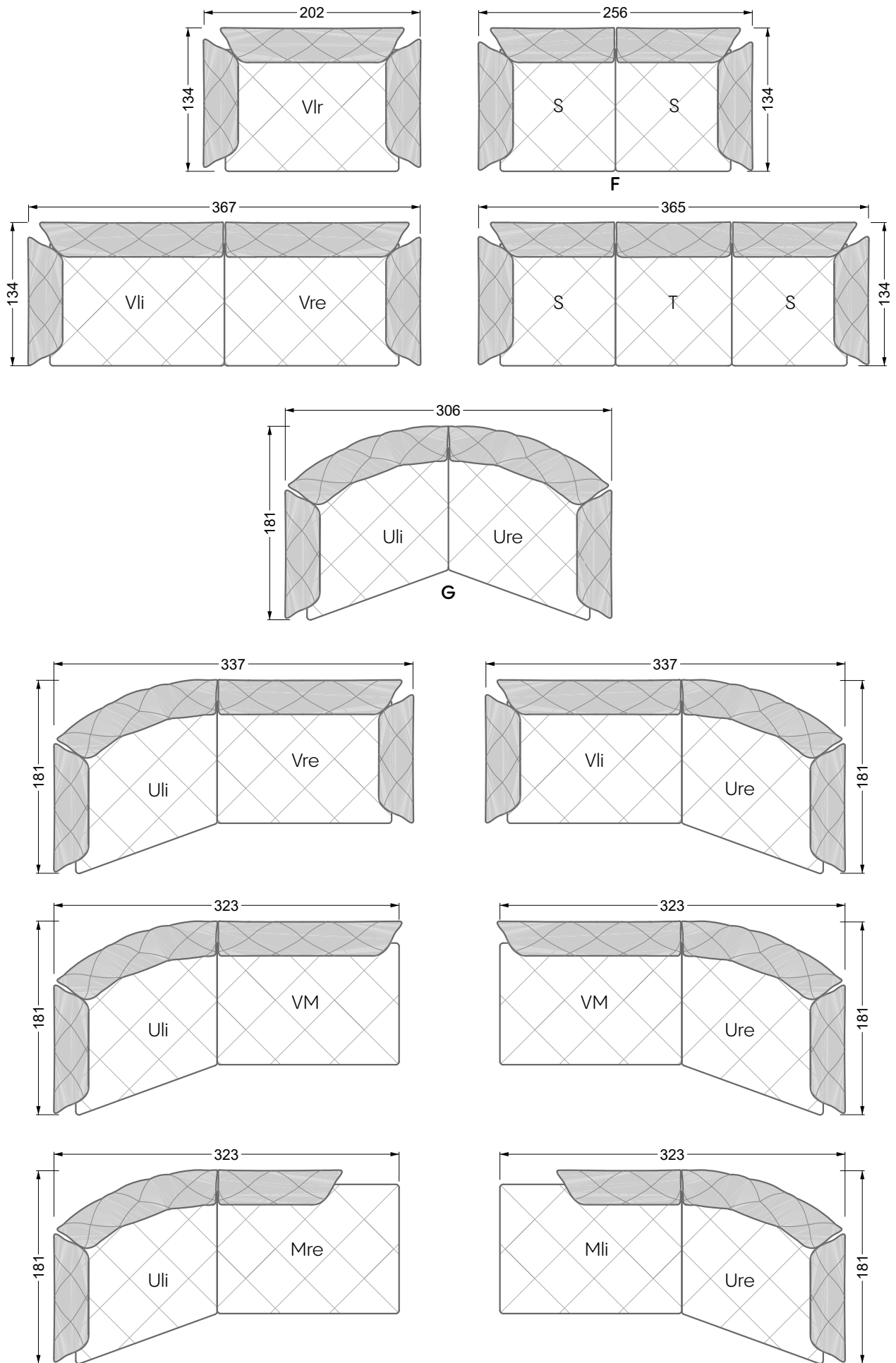

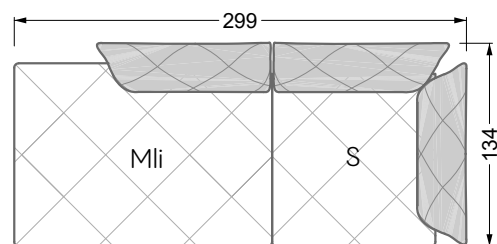
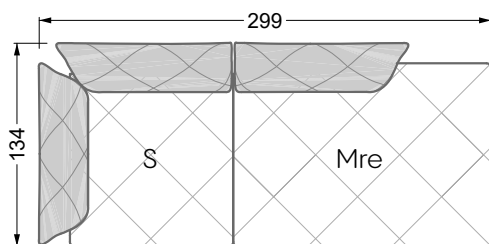
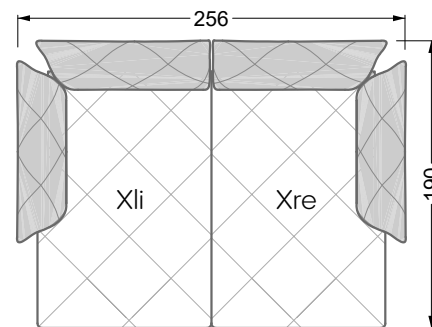
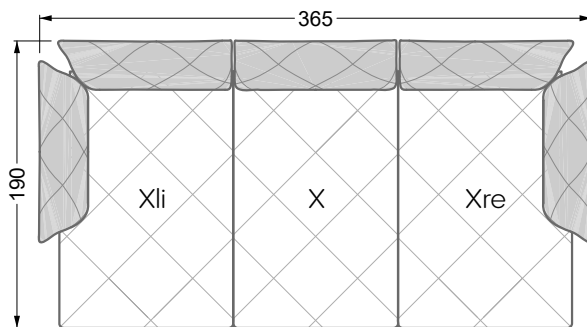
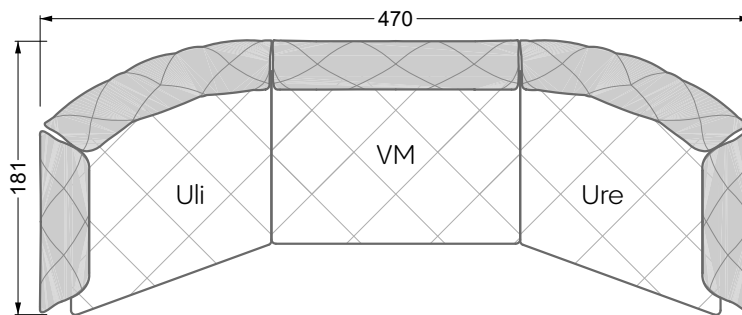
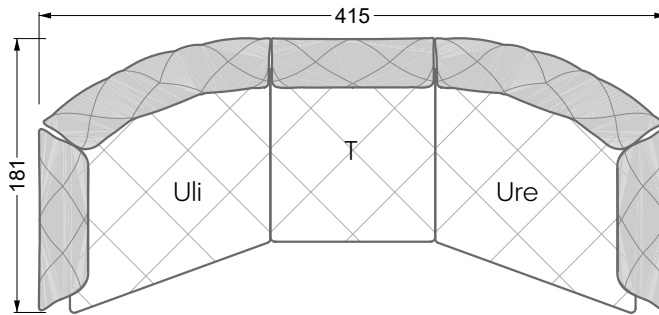
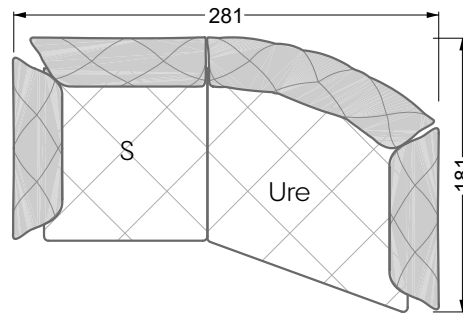
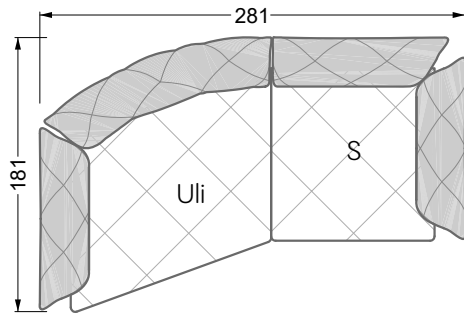

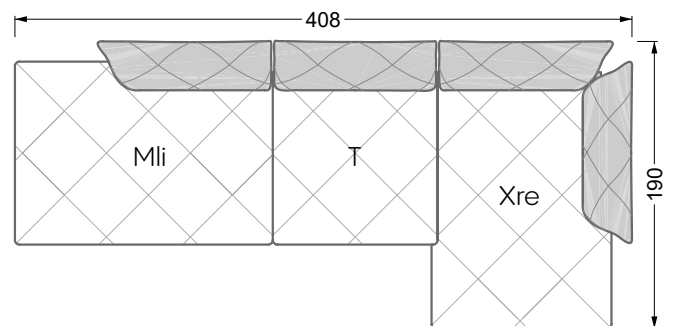
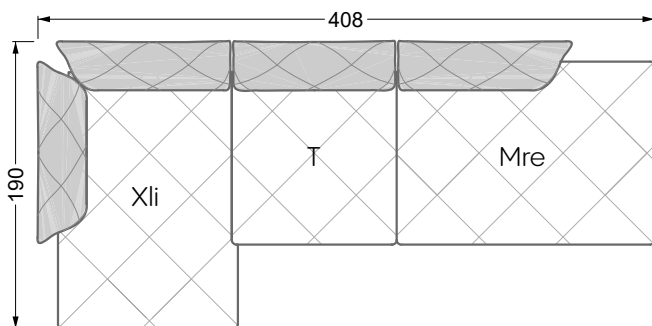
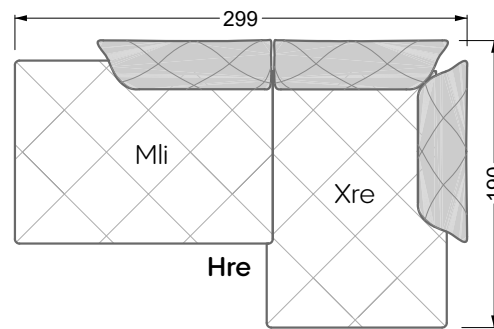
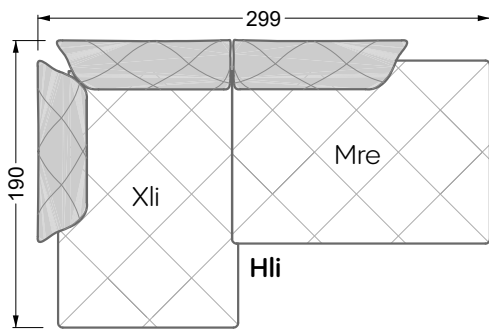
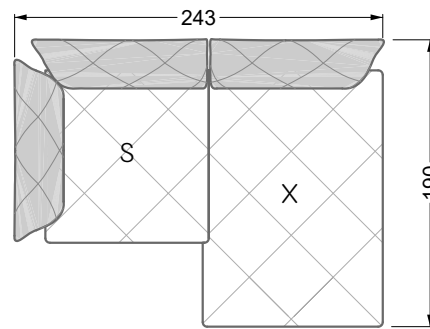
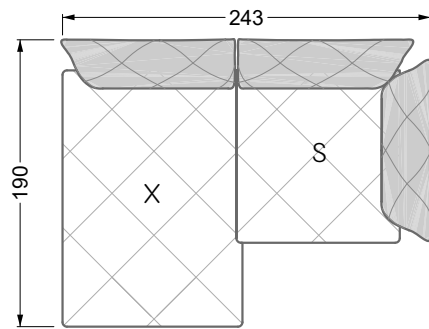
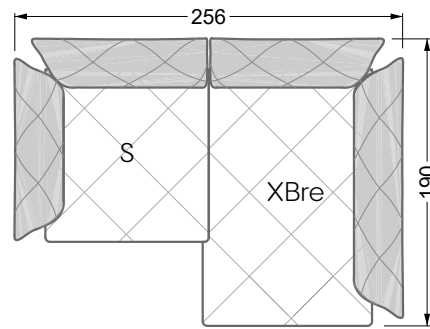
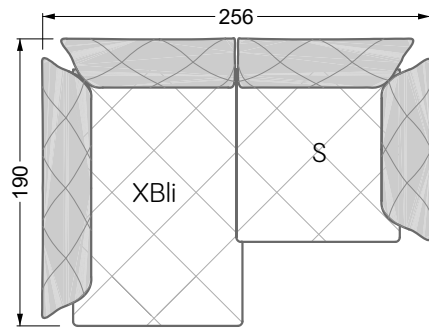
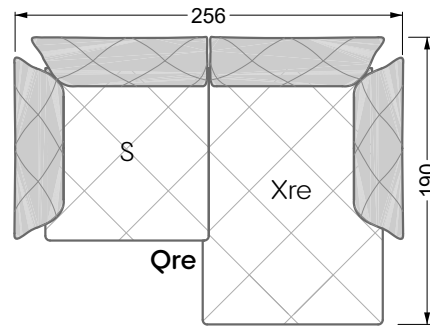
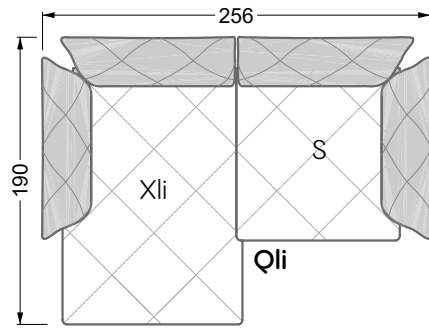

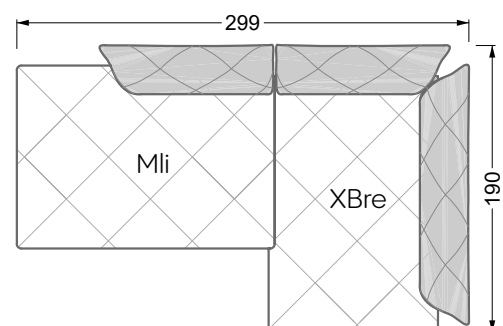
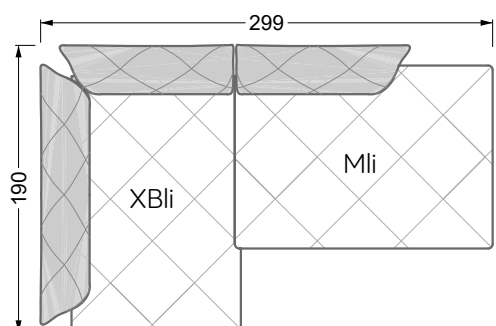
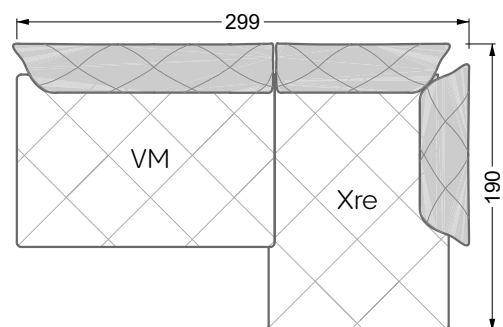
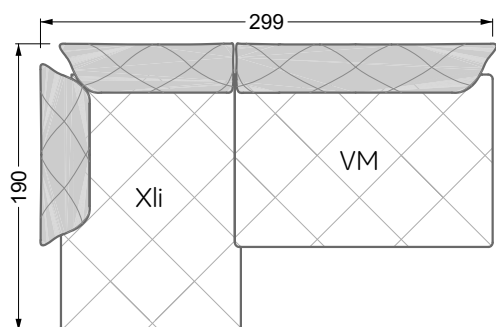
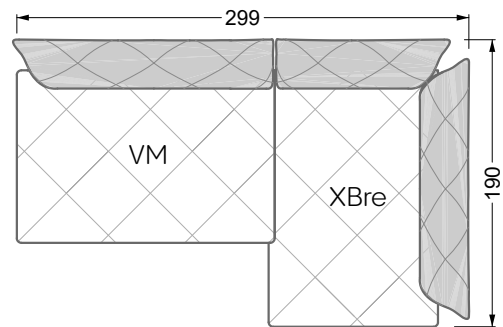
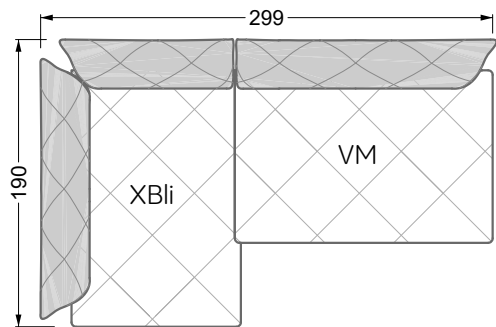
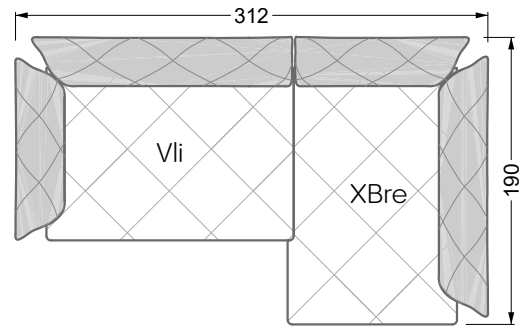
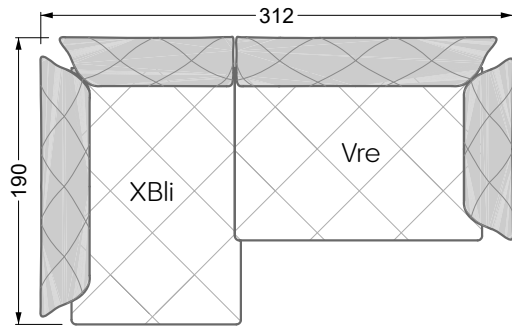
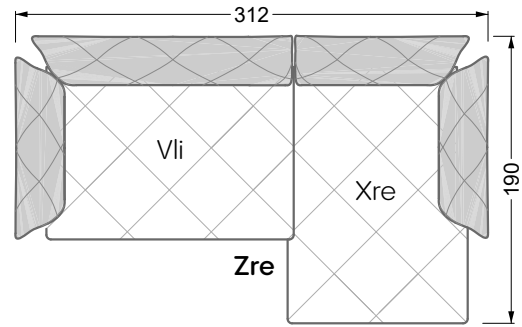
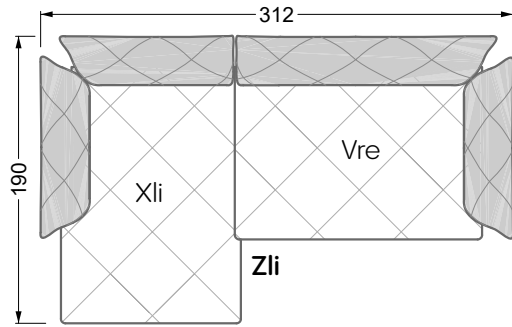

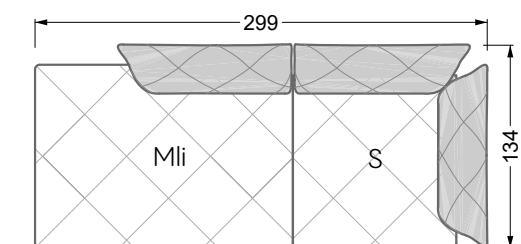
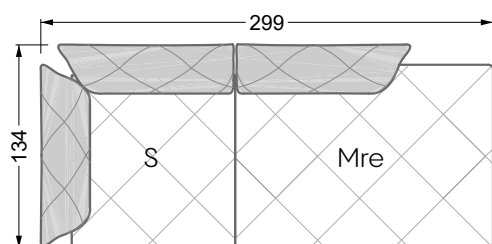
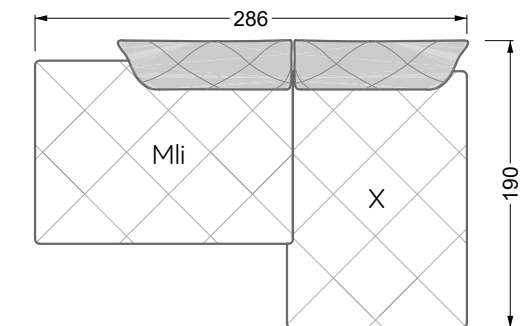
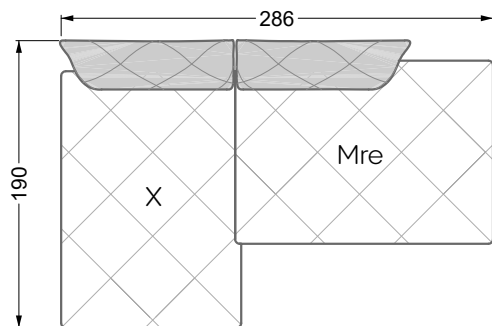
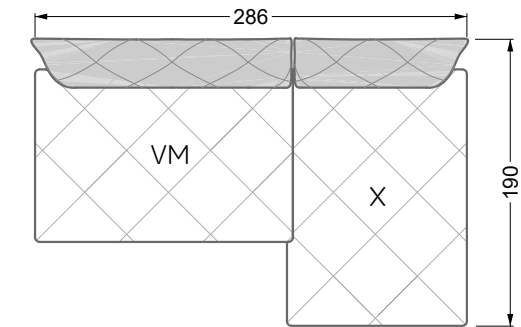
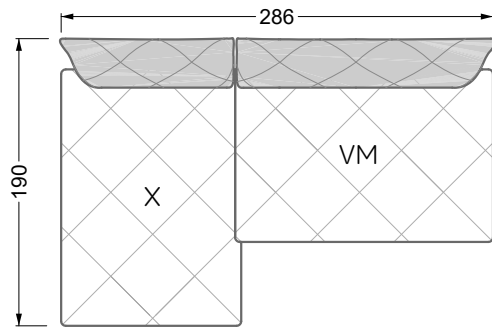
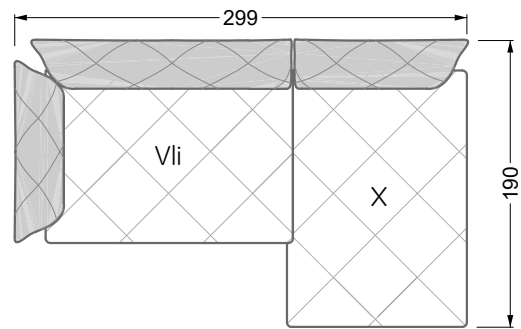
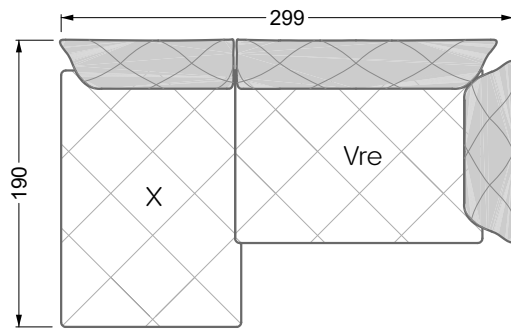
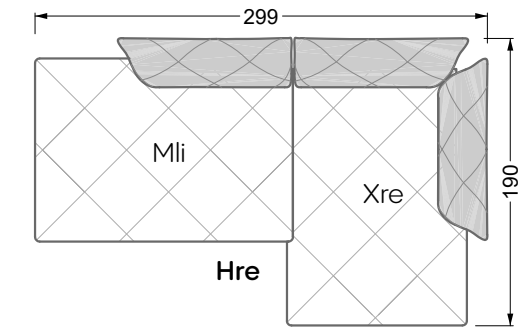
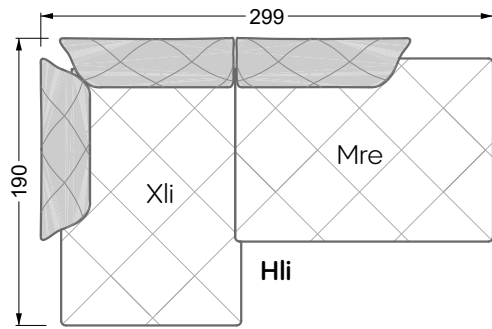

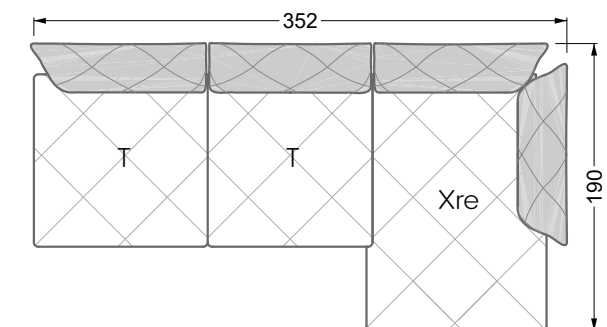
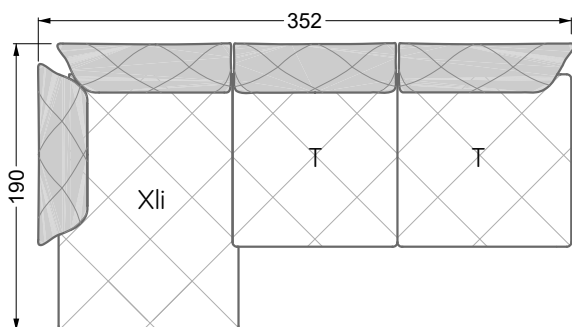
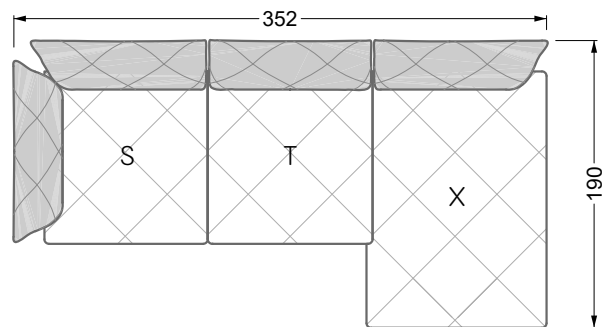
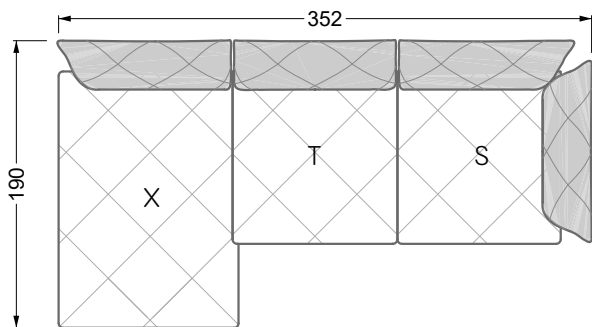
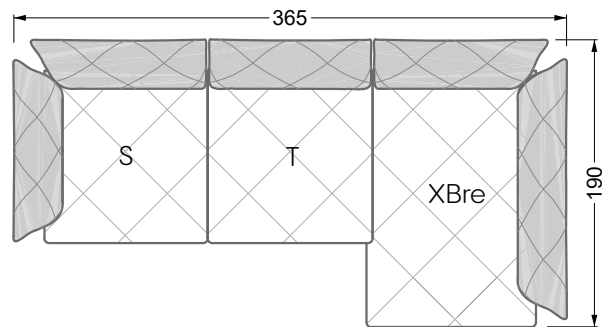
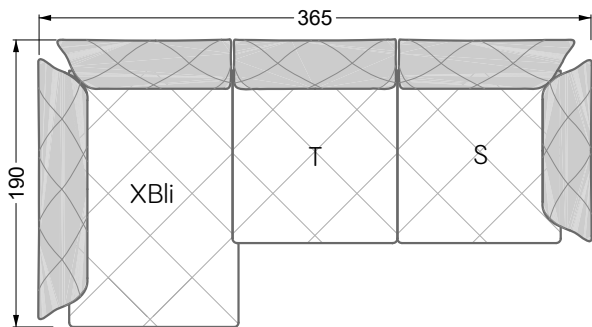
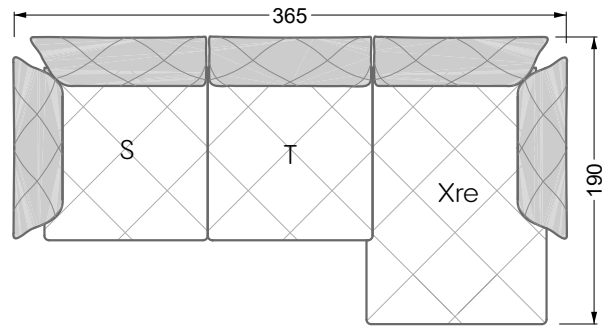
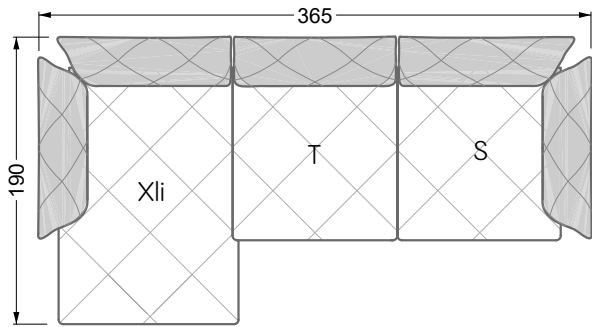

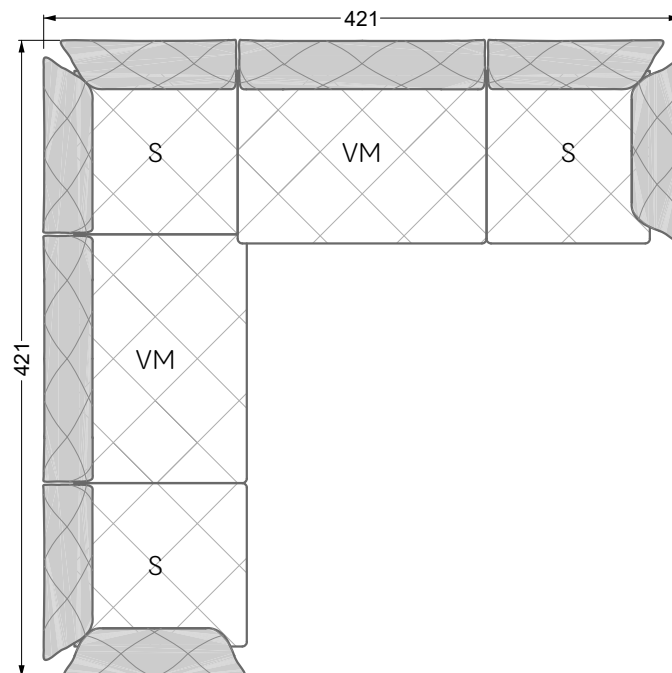
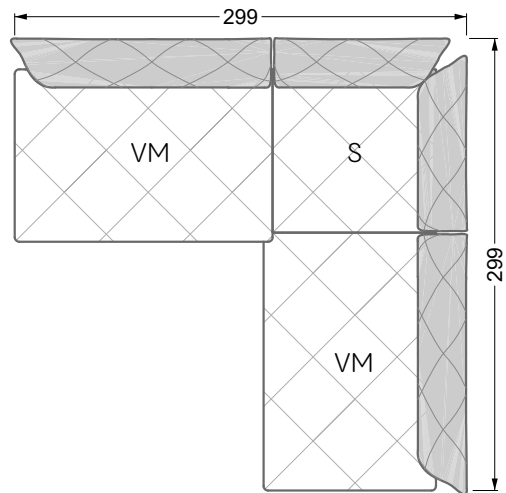
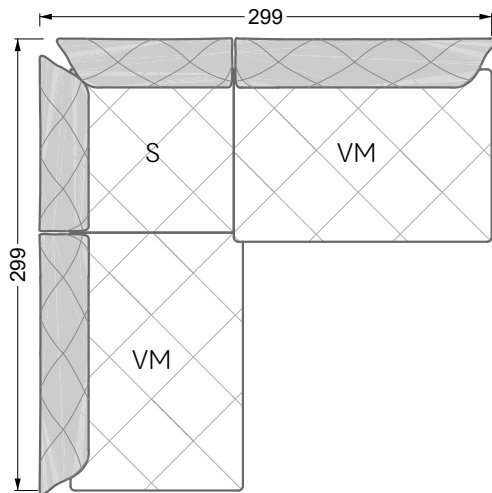
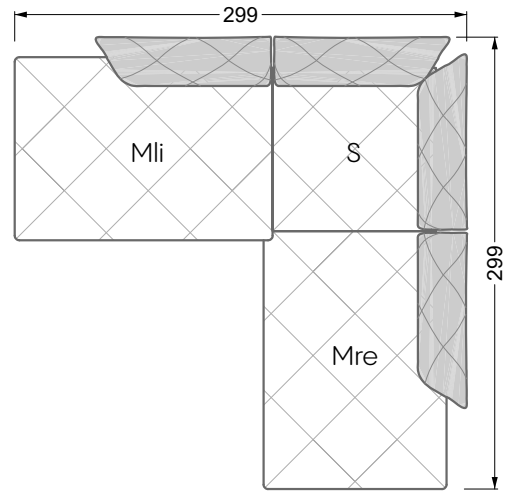
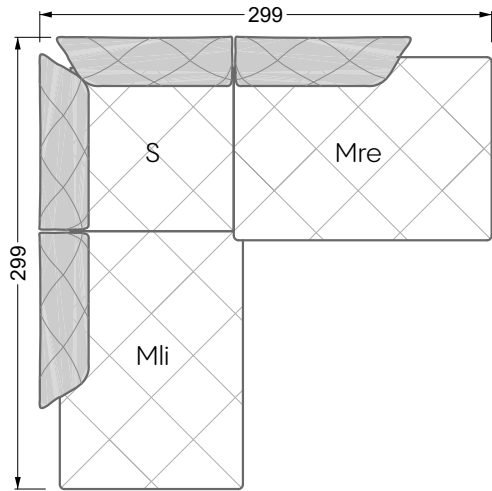

Teratai

106 • Ecksofas symmetrisch / asymmetrisch

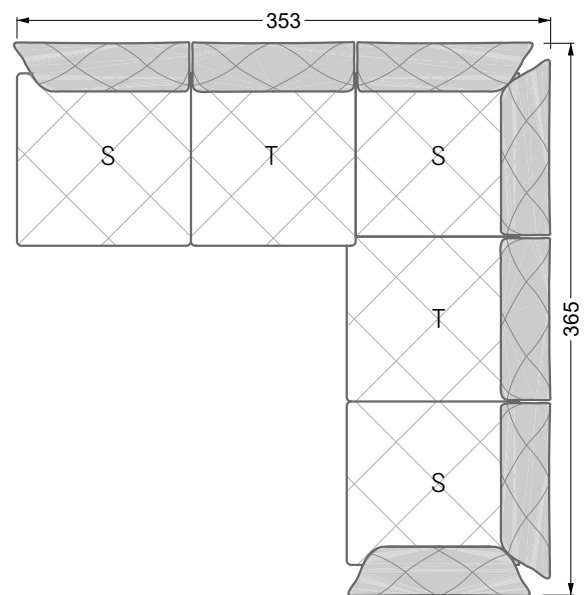
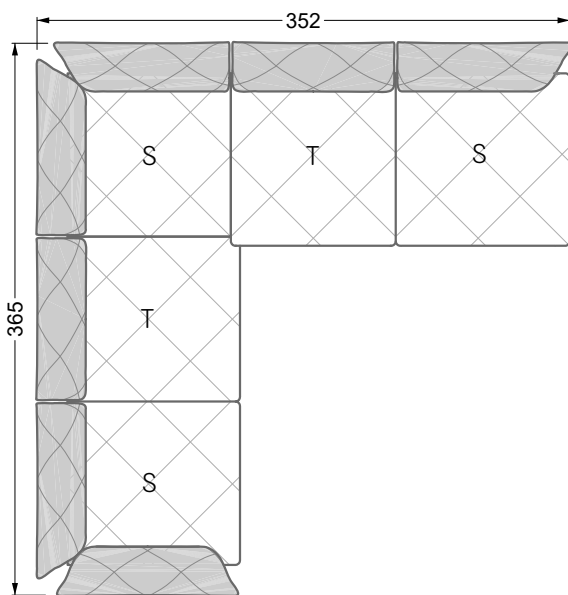
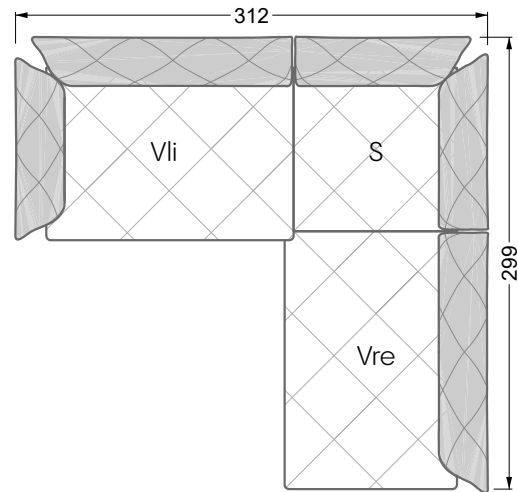
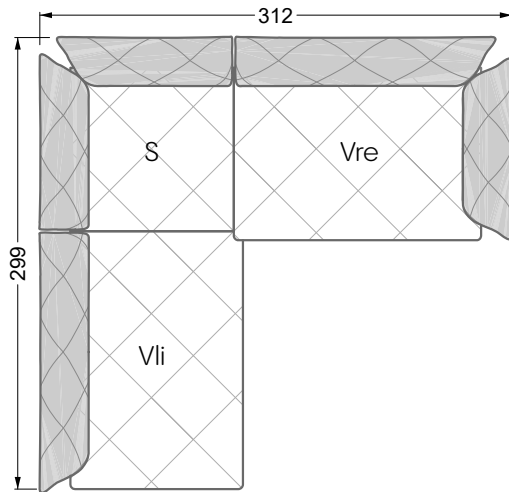
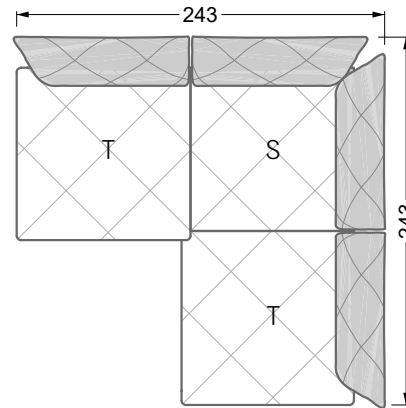
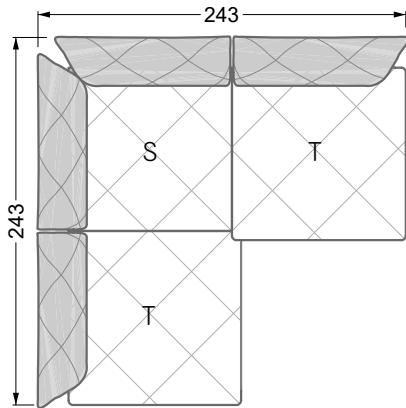

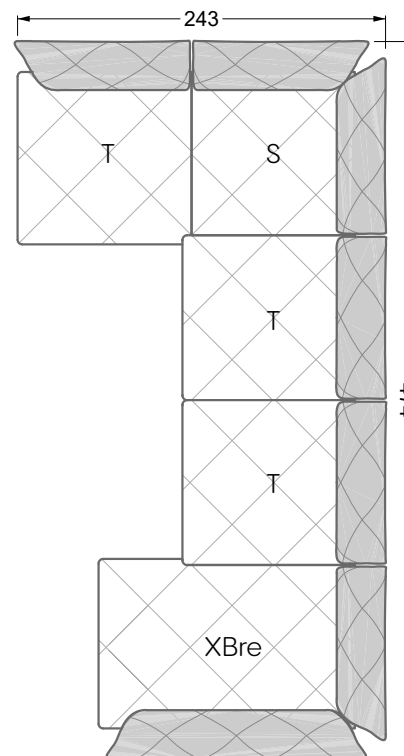
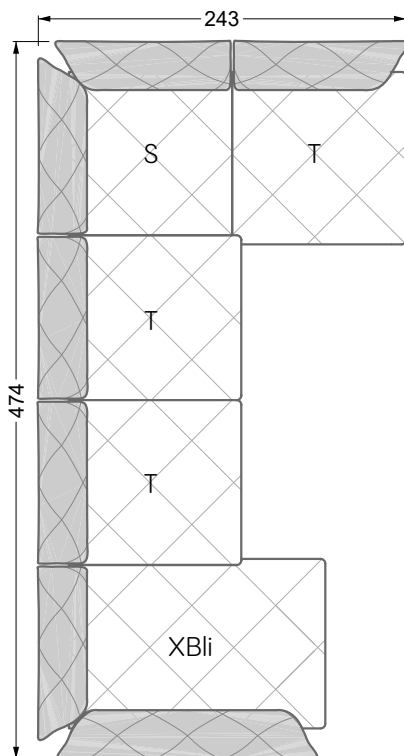
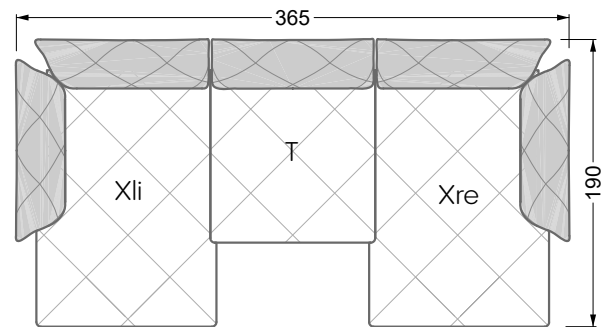
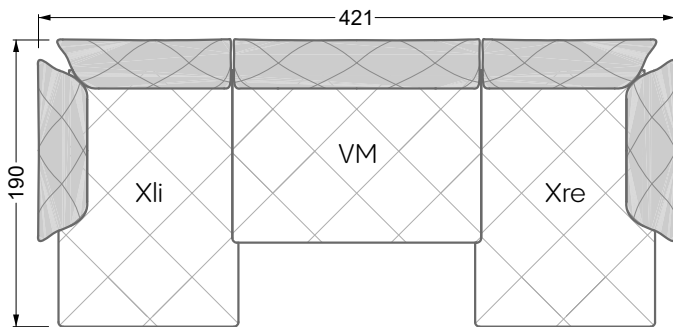
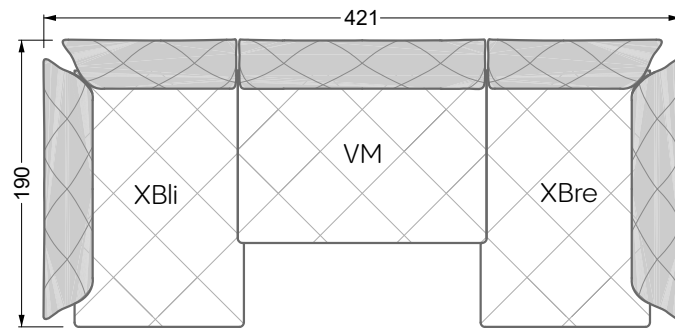

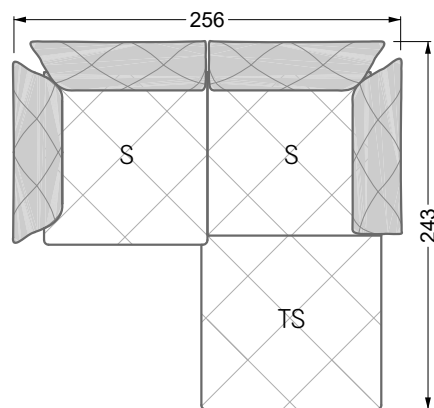
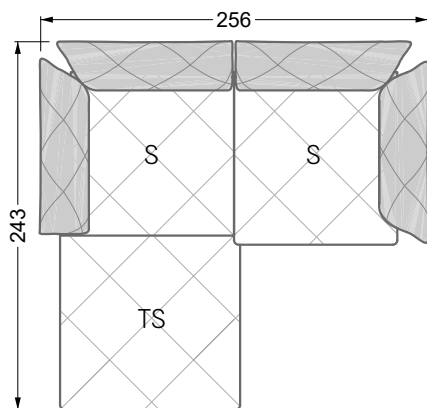
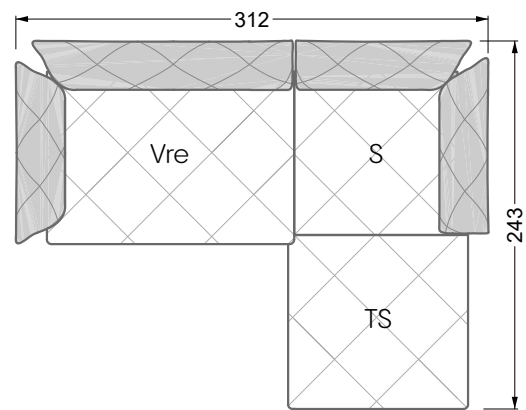
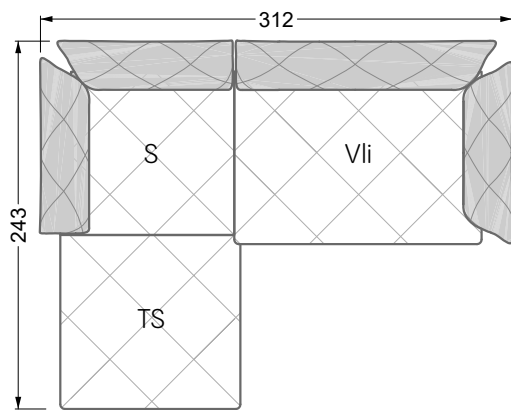
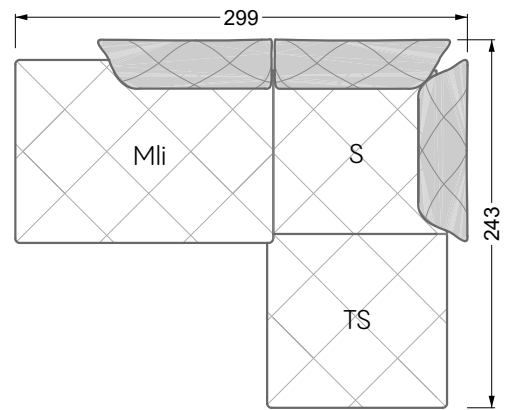
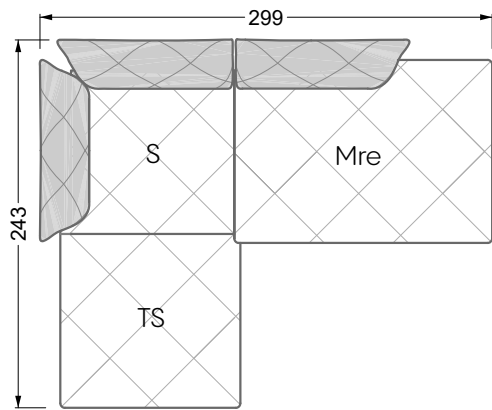
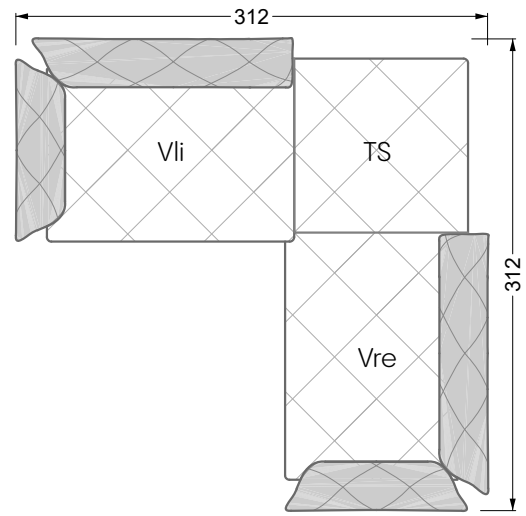
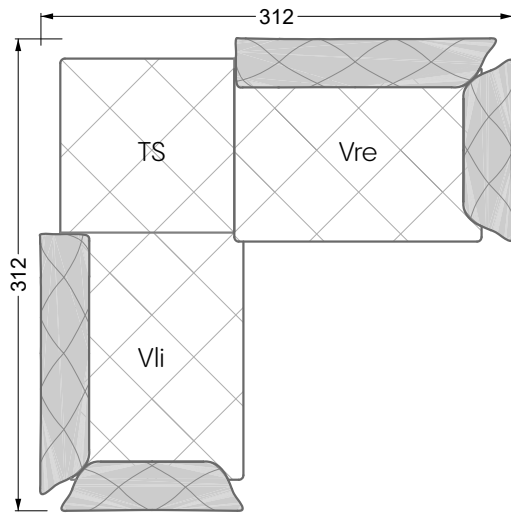



Bretz
German Manufacture
Since 1895

Head Office & Showroom:

Alexander-Bretz-Str. 2
D-55457 Gensingen
Tel +496727-895-0
E-Mail info@bretz.de

Bretz Sales Flagships & Partners:
bretz.de

f BretzSofas
@bretz_sofas

Bretz
True Characters