

# Cloud 7



**DOWNLOAD LINK:** [HTTPS://BRETZ.MEDIA/EN/DOWNLOAD/CLOUD7-PRESSRELEASE](https://bretz.media/en/download/cloud7-pressrelease)  
**CONTACT:** MEIKE STEINBERG **FON:** +49-172-614 36 01  
[MEIKE.STEINBERG@BRETZ.DE](mailto:MEIKE.STEINBERG@BRETZ.DE) | [HTTPS://BRETZ.COM](https://bretz.com) | [HTTPS://BRETZ.MEDIA](https://bretz.media)



# Cloud 7

## Philosophy

We love the extreme! Edges and corners, a sharply cut silhouette, deep, soft indentations: that can only be Cloud 7. Our Bretz classic Cloud 7 has been a favourite for ten years. The reason for that is the futuristic design of our character, which reminds of a celestial body due to its retro futuristic style. Cloud 7 is not a spaceship, it's not a cloud, Cloud 7 is something in-between. A new and distinctive shape, which combines comfort and configurability and creates a completely new feeling.



# Cloud 7

## Facts & Highlights

- Cloud 7 is the ultimate Bretz-classic
- High quality sewing
- Modular system with two seating depths for more individuality
- No 90° angle
- Unconventional layouts.

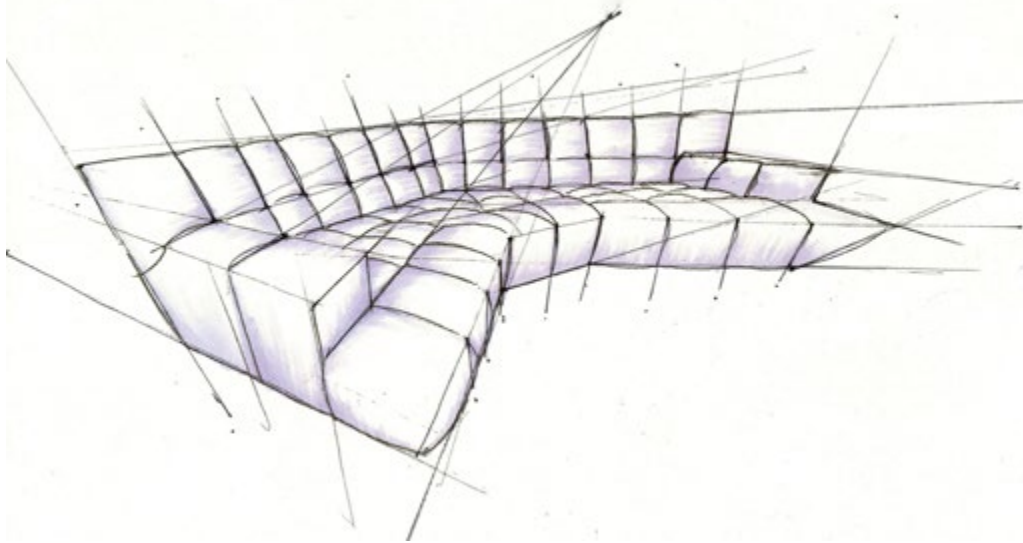
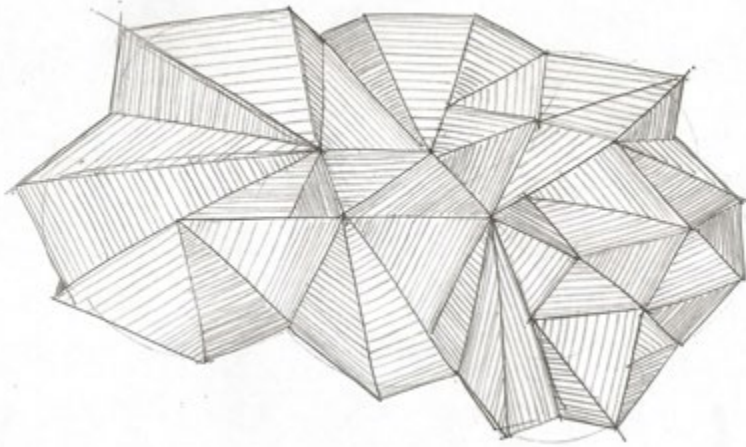

# Cloud 7

A sofa for individualists

One thing is clear: We wanted to create a sofa with an extraordinary layout, a strong and unmistakable form, which also has a maximum of independence and character. And it's also comfortable! A sofa that is different from all the others. Not only are the layouts, which can be created with Cloud 7, one of a kind. The sewing has no rivals. The foams are finally balanced, and the sewing has not one (!) right angle – which fits perfectly into the dynamic form.



# Cloud 7

Your new favourite spot

No matter if you live in a spacious loft or in a modern high-rise: Cloud 7 will fit into your surroundings. Next to its almost never ending possibilities of combining its elements, there are also a vast number of cover fabrics from which you can choose the right velour for your needs. That's how Cloud 7 turns into your own personal beautiful piece. Cloud 7 is not simply a sofa – it is your new favourite spot!





# Cloud 7

The inner values are just right

The reason for that is of course the balanced foam-mixture. Cloud 7 has a stable, wooden frame and a softly swinging Nosag- and Bonell spring core. Foams in different densities and degrees of hardness were piled up and combined masterfully in order to guarantee that heavenly soft seating comfort. The single "cassettes" of the padding should softly cling to the body, give way and bring stability all at the same time. Not an easy task to fulfil, but in the end it wasn't really a problem for our padding professionals. On top of that goes a thick fleece padding which makes the corners and edges comfortable and inviting. The last layer is a cover which softly snuggles up and makes Cloud 7 complete.

# Cloud 7

## Configuration: Diversity of modules

Especially the classic Cloud 7 cover “Silberschimmer” (silver shimmer), really brings out the futuristic and dynamic form of Cloud 7! The individual configurability, due to the combination of different modules with various seating depths, allows for an ideal solution in every room. Check it out for yourself:

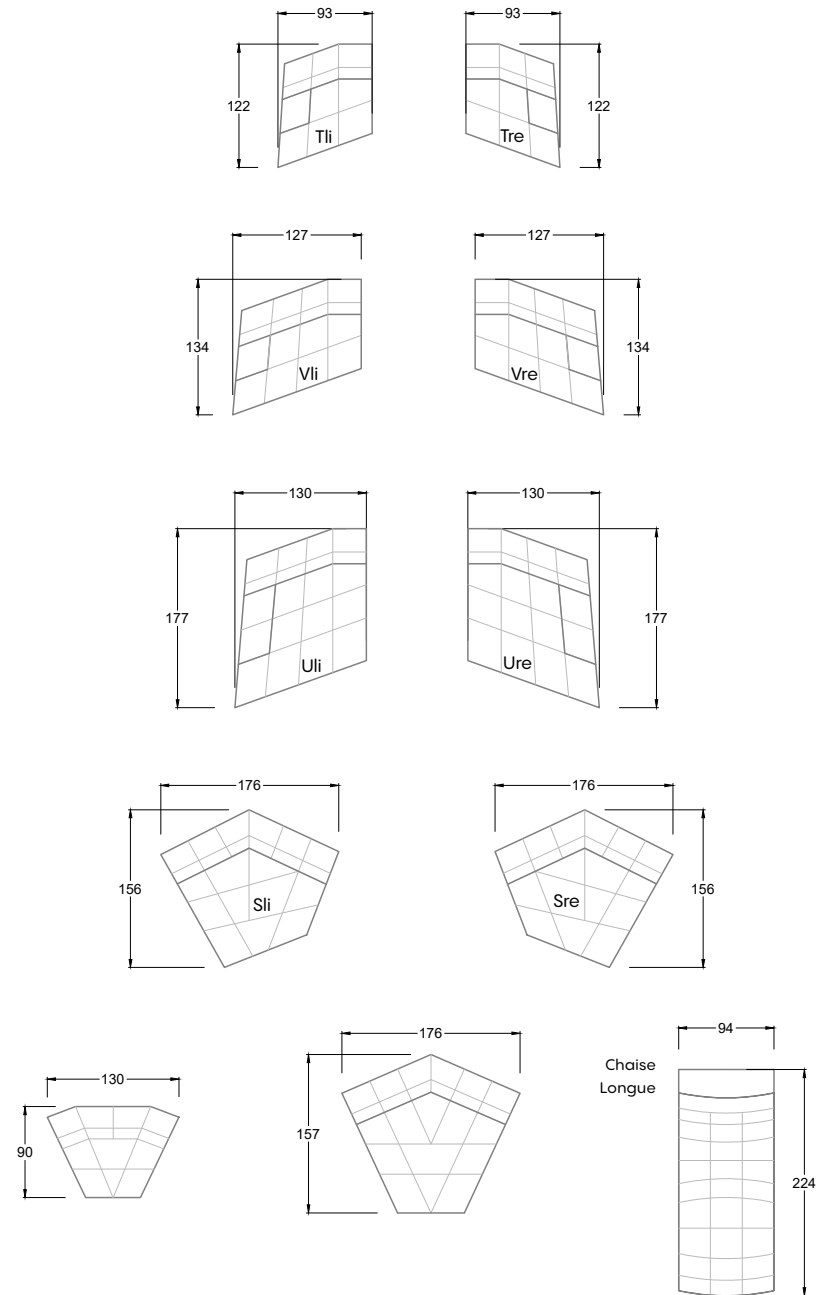

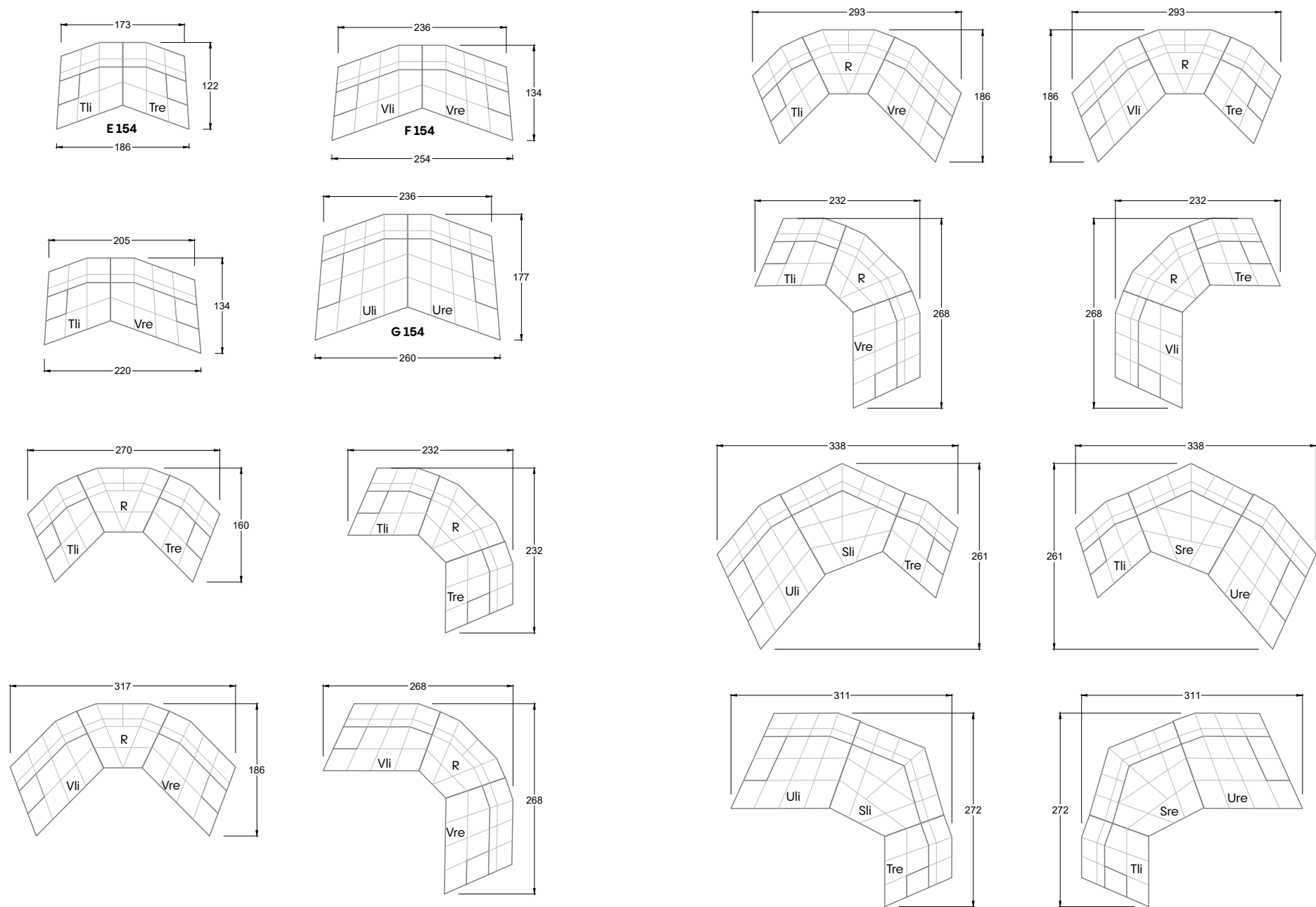



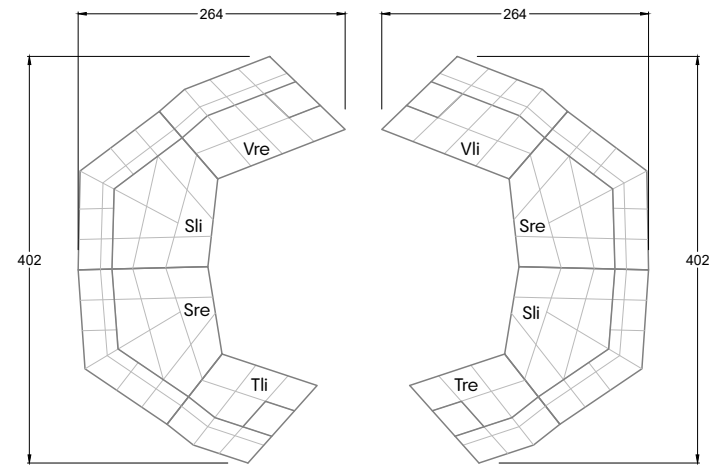
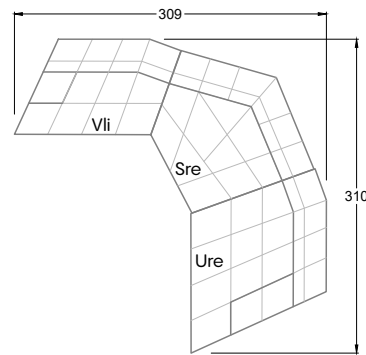
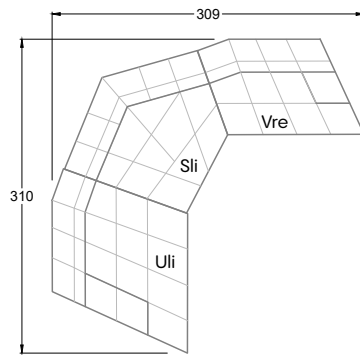
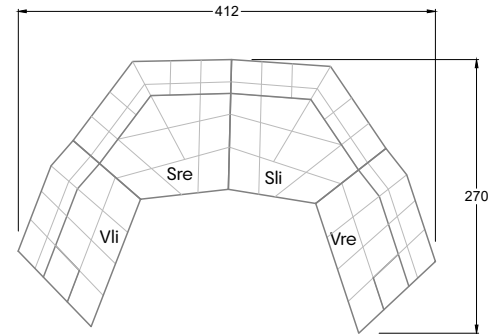
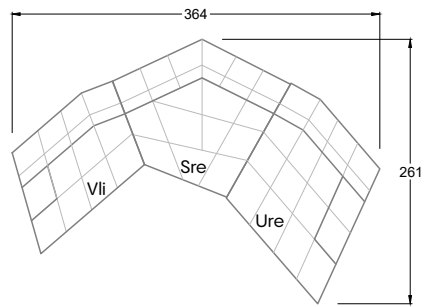
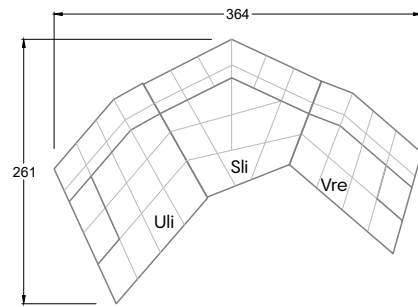
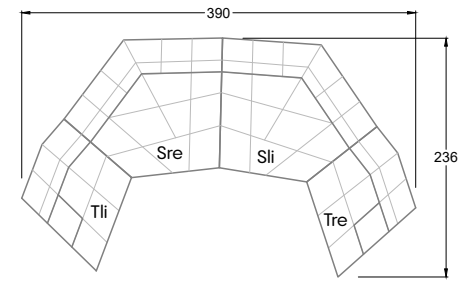
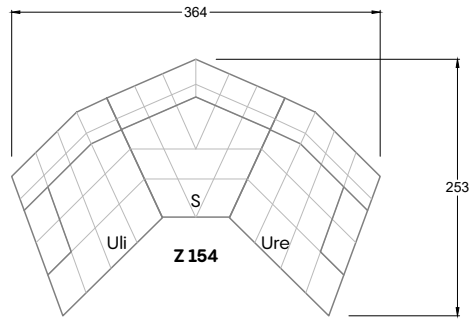
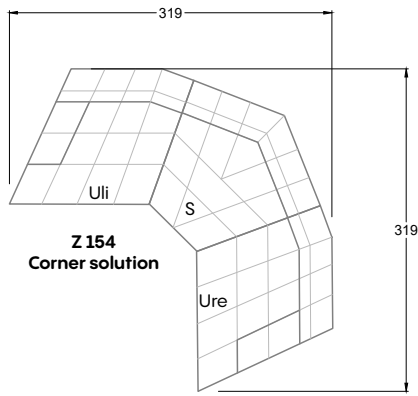

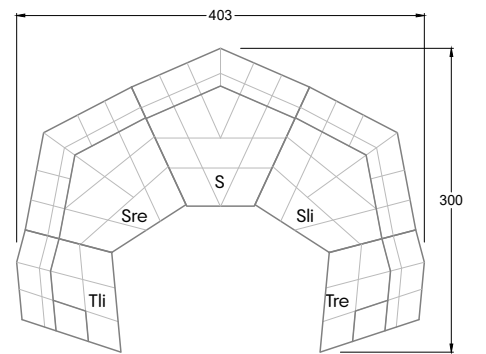
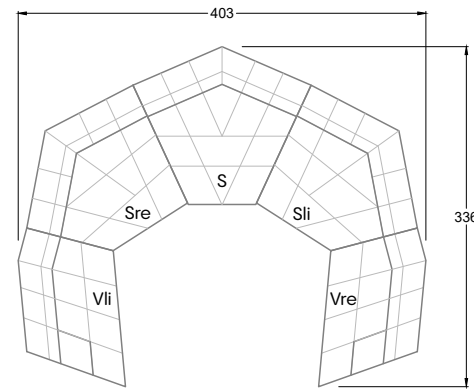
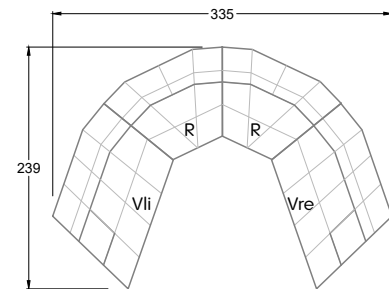
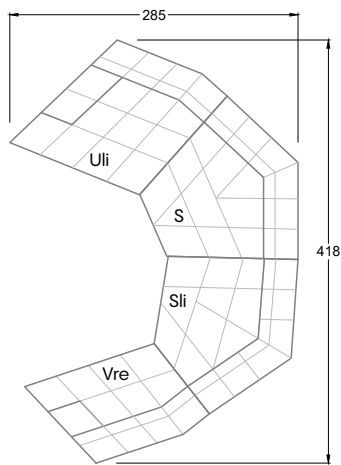
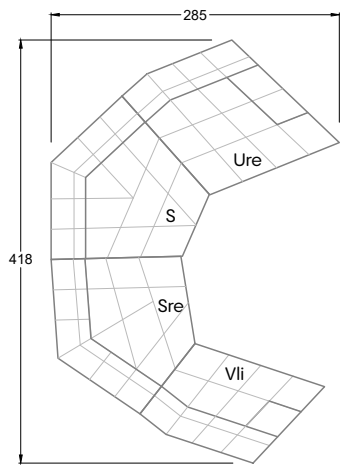
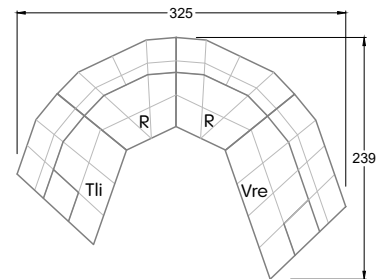
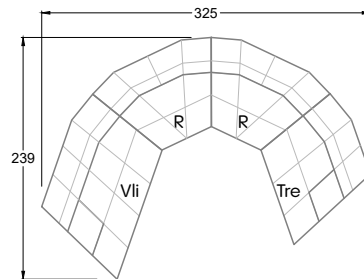
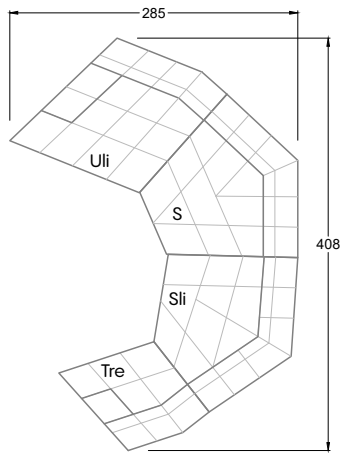
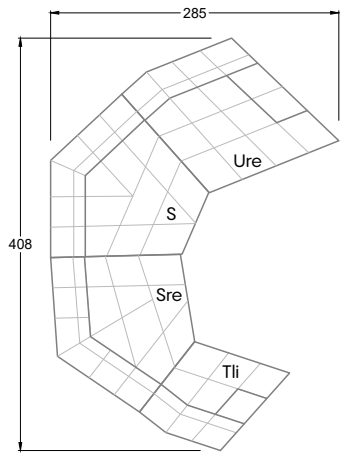
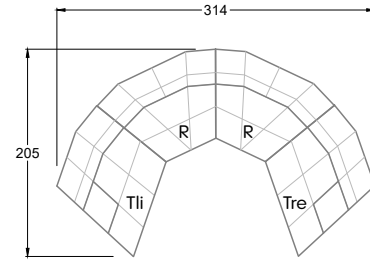
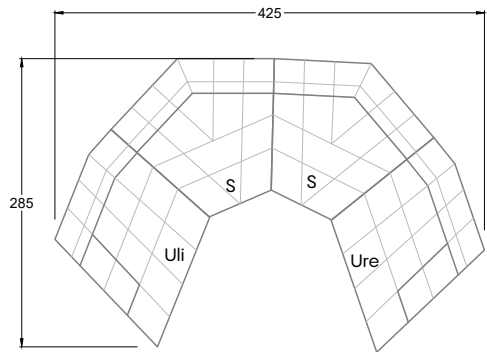

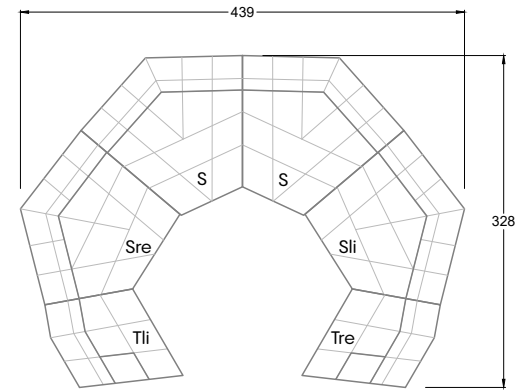
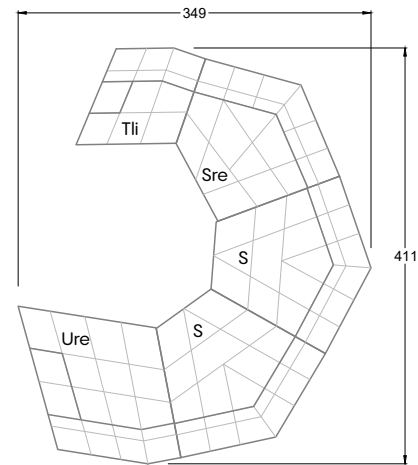
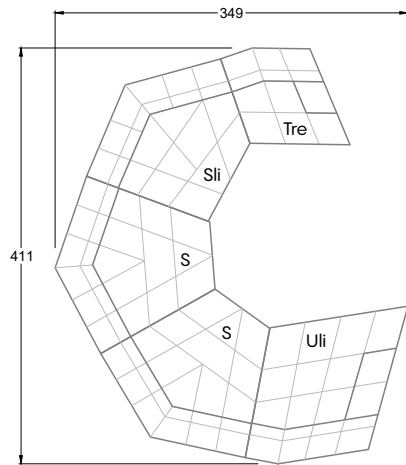
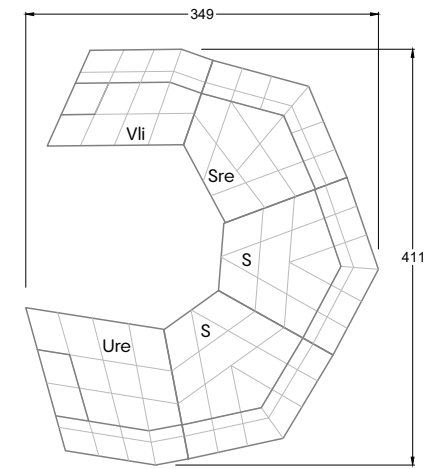
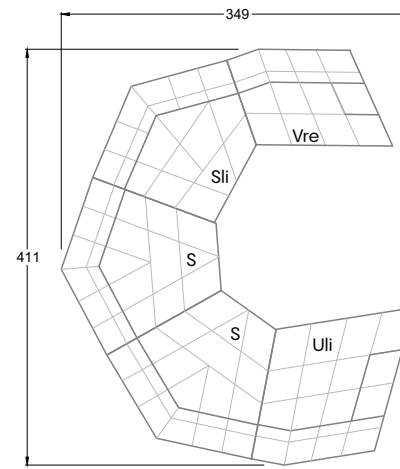
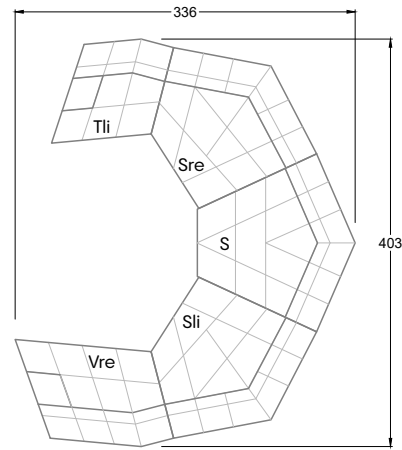
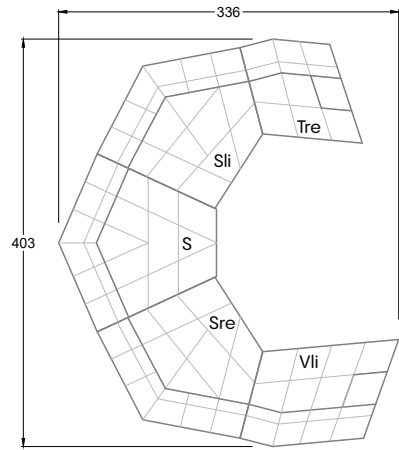

# cloud 7



COLLECTION CLOUD 7

Bretz