

Creole

Produktdaten

Product information
Information produits

Bretz
True Characters

To sleep perchance to dream

Nichts ist erholsamer für den Körper als ein tiefer, gesunder Schlaf. Deshalb setzen wir bei unseren Boxspringbetten nicht nur auf außergewöhnliches Design, sondern vor allem auch auf die besten Qualitäten was Matratzen, Taschenfederkerne und Schäume angeht.

All night long.

- 28 cm hohe Boxspring-Obermatratze mit 7 Zonen
- 1800 einzeln umhüllte, 12 cm hohe 7,5-Gang-Taschenfedern in einer 2 x 2 m Matratze
- 85 mm starke Hochleistungskaltschaumabdeckung (Raumgewicht 70 kg/m³)
- Punktelastischer, oben abnehmbarer und waschbarer Nicky-Bezug (optimale Feuchtigkeitsaufnahme)

Nothing does us more good than a night of deep and restful sleep. Which is why our divan beds not only feature an unusual design but are careful to include high-quality mattresses, pocket springs and foam parts that the Sandman himself would approve of.

All night long.

- Box-spring top mattress, 28 cm high with 7 zones
- 1800 individually wrapped 12 cm tall, 7.5-coil pocket springs in a 2 x 2 m mattress
- 85 mm-gauge high-performance memory foam covering (density 70 kg/m³)
- Point-elastic, top removable, washable velour cover (to ensure optimum moisture wicking)



Des nuits paisibles

Rien n'est plus relaxant pour le corps qu'un sommeil sain et profond. C'est pour-quoi nous accordons beaucoup d'importance au design exceptionnel de nos lits Boxspring, mais surtout à la meilleure qualité pour nos matelas, ressorts ensachés et mousses utilisées. All night long.

- Matelas supérieur Boxspring de 28 cm d'épaisseur à 7 zones
- 1800 ressorts ensachés individuels 7,5 tours et 12 cm de hauteur dans un matelas de 2 x 2 m
- Revêtement mousse à froid très haute résilience de 85mm (densité: 70 kg/m³)
- Housse extensible, amovible et lavable en tissu éponge (parfaite absorption de l'humidité)

Collection **Creole Bed**



W 129-180 Creole (Set 3) ▶283,5 cm ▼224 cm ▲147 cm
Stoff · Fabric · Tissu **65 BOH73 / 65 BOH71 / 65 BOH75**



W 129-180, 2 × RP129-100-2, 1 × RP129-100 Creole ▶202,5 cm ▼216 cm ▲147 cm
Stoff · Fabric · Tissu **65 BOH71**

Creole Bed



W 129-180 Creole ▶ 196 cm ▼ 216 cm ▲ 55 – 59 cm
Stoff · Fabric · Tissu **65 BOH76**



Wasserfall 129
RP200, RP180, RP160, RP140, RP120, RP100, RP80
Stoff · Fabric · Tissu **65 BOH86 / 65 BOH78 / 65 BOH75 / 65 BOH73 / 65 BOH70 / 65 BOH41 / 65 BOH63**

Creole créative

Creole inszeniert das Oval auf signifikante Weise. Die Wiederholung des symmetrischen Motivs wächst zum Ornament heran, dessen Kraft an den Stil des Art déco erinnert. Nach Belieben lassen sich die Rund-bögen zusammenstellen und an der Wand immer wieder neu arrangieren – ob horizontal oder vertikal, ob asymmetrisch oder stufenweise, ob Ton in Ton oder kontrastreich.

Die Wandpaneele sind in sieben Längen erhältlich sowie mit einer Vielzahl aus schimmernden Bezügen und Farben. Sie lassen sich ganz einfach und auch vom Bett unabhängig an die Wand montieren. So können die „Creolen“ als Bettrücken dienen oder werden zum komplementierenden Wandbild.

Collection **Creole Bed**



W 129-180, 2 × RP129-100-2, 1 × RP129-100 Creole ▶ 200,5 cm ▼ 216 cm ▲ 147 cm
Stoff - Fabric - Tissu **65 BOH71**

Creole créative

Creole re-stages the oval in a significant way. The repetition of the symmetric motif grows into an ornament, which strongly reminds of Art Deco. The arches can be arranged according to your heart's desire and re arranged along the wall in which ever way pleases: horizontally or vertically, a-symmetrical or progressively, tonal or full of contrasts.

The wall panels are available in seven lengths and come in a host of different covers and colors. This way, the arches can be used as headboards or as murals.

Collection **Creole Bed**



W 129B-180 Creole (Set 2.2) ▶ 243 cm ▼ 224 cm ▲ 147 cm
Stoff · Fabric · Tissu **65 BOH54 / 65 BOH58 / 65 BOH74**



W 129-180, 1 · RP129-200-2 Creole ▶ 200,5 cm ▼ 216 cm ▲ 128 cm
Stoff · Fabric · Tissu **65 BOH54**

Creole créative

Creole met en scène l'ovale de manière significative. La répétition du motif symétrique devient un ornement qui n'est pas sans rappeler la force et le style de l'art-déco.

Les arrondis peuvent être arrangés à volonté et réarrangés sur le mur, à l'horizontale ou à la verticale, de façon symétrique, asymétrique ou graduelle, ton sur ton ou avec contraste.

Les panneaux muraux sont disponibles dans sept longueurs et de nombreuses couleurs et tissus scintillantes sont disponibles. Ils sont très faciles à monter sur le mur, même depuis le lit. Ainsi, les Creoles peuvent servir d'ornement de lit ou de décors muraux complexes.



W 129 C-180, 2* RP 129-120, 4* RP 129-80 Creole
▶243 cm ▼224 cm ▲127 cm Stoff · Fabric · Tissu **65 BOH06**

Collection **Creole Bed**



Facts & Highlights

- Modularität durch kreative Anordnung der bogenförmigen Wandrückenpaneele (Creoles): 4 bis 9 Creoles im 40,5 cm Raster kombinierbar oder horizontal max. 2 Creoles übereinander
- Einfache Wandmontage über eine Leiste
- Rückenpaneele bilden auch ohne Bettkasten dekorative Wandbilder oder Polsterrücken für bestehende Sitzelemente
- Bettkorpus auch ohne Rückenteil erhältlich. Ideal für Dachschrägen oder Einsatz frei im Raum
- Matratzen-Breiten: 160 / 180 / 200 cm
- Modularity through creative arrangement of the arched wall-back panels (Creoles): 4 to 9 Creoles in 40.5 cm grid can be combined, or a max of 2 Creoles can be put horizontally
- Easy fitting to walls due to a bar
- Back panels can form decorative murals or upholstered backs for already existing seating elements, even without the bed base
- Bed corpus available without back part; ideal for sloping roofs or to be put in the middle of a room
- Mattress width: 160 / 180 / 200 cm
- Modularité grâce à la disposition créative des panneaux arrière en forme d'arche (creoles) : 4 à 9 creoles peuvent être combinés dans une trame de 40,5 cm ou 2 creoles max. superposés à l'horizontale
- Montage mural simple au moyen d'une baguette
- Même sans sommier, les panneaux arrière constituent un panneau mural décoratif ou un support pour les éléments d'assise existants
- Corps de lit disponible également sans tête de lit. Idéal pour l'installation sous mansardes ou librement dans une pièce
- Largeurs de matelas : 160 / 180 / 200 cm

W 129 A-180 Creole (Set 1.2) ▶243 cm ▼224 cm ▲147 cm
Stoff · Fabric · Tissu **65 BOH84 / 65 BOH14 / 65 BOH76**



W 129-180, 1 RP129-180-2 Creole ▶196 cm ▼216 cm ▲127,5 cm
Stoff · Fabric · Tissu **65 BOH50**

Boxspring-System-Matratze

Kaltschaum-Matratze

W 129-160

Liegefläche
160 x 200 cm

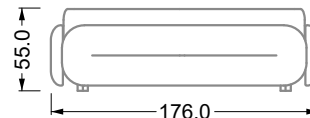
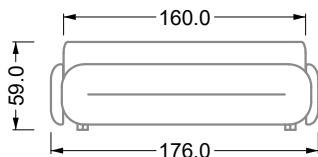

W 129-180

Liegefläche
180 x 200 cm

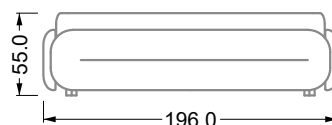
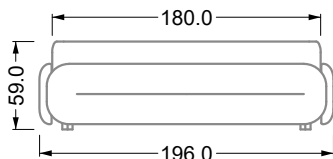

W 129-200

Liegefläche
200 x 200 cm

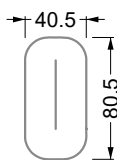
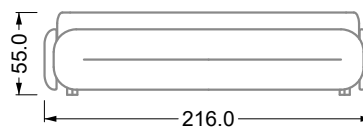
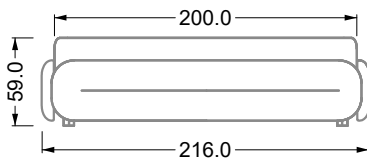

A

RP 129-80

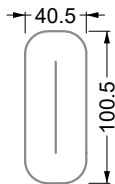

B

RP 129-100



C

RP 129-120

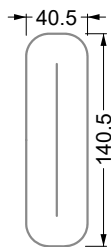

D

RP 129-140



E

RP 129-160

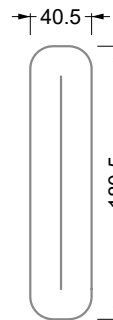

F

RP 129-180

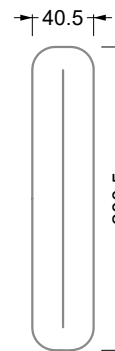

G

RP 129-200

W 129-160

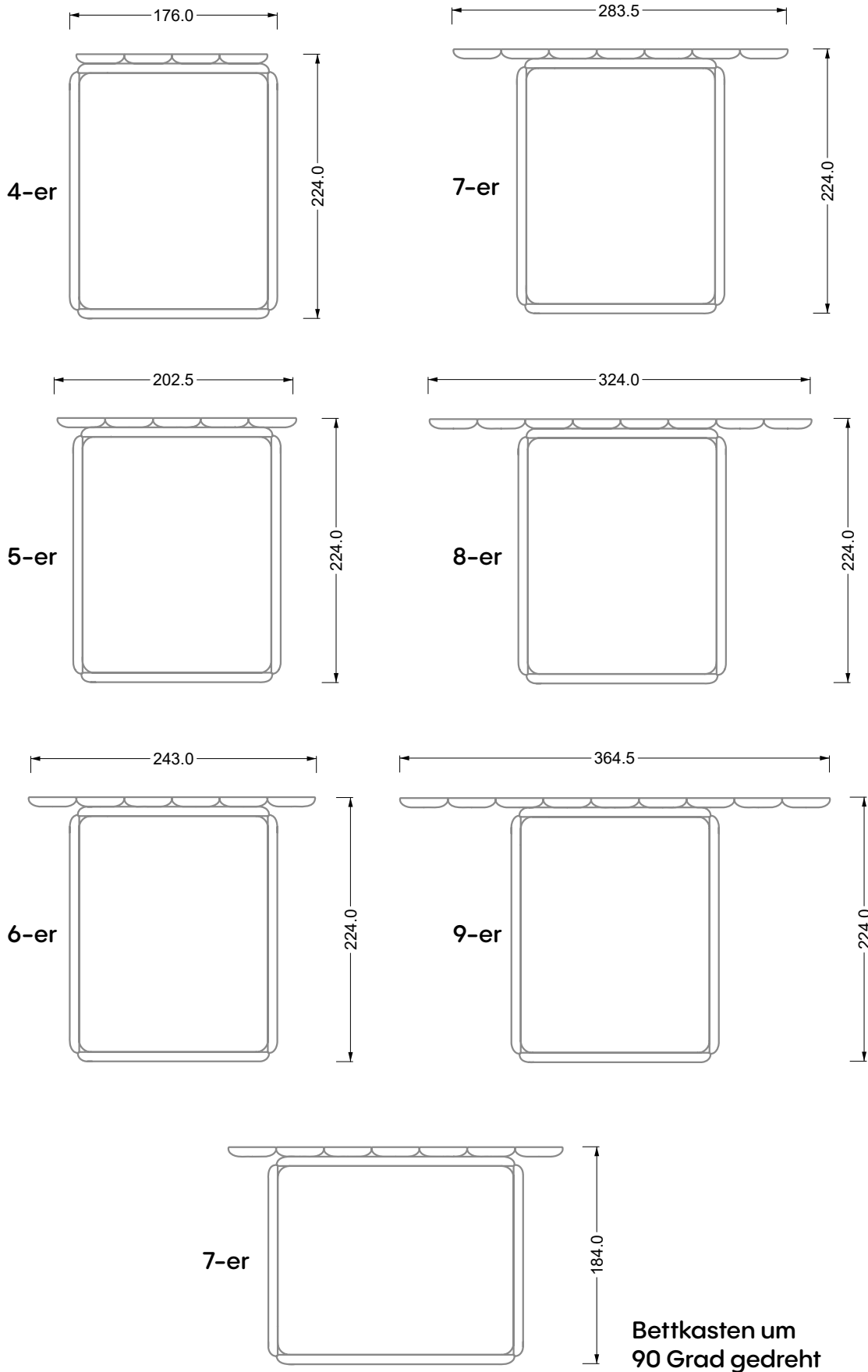

W 129-160

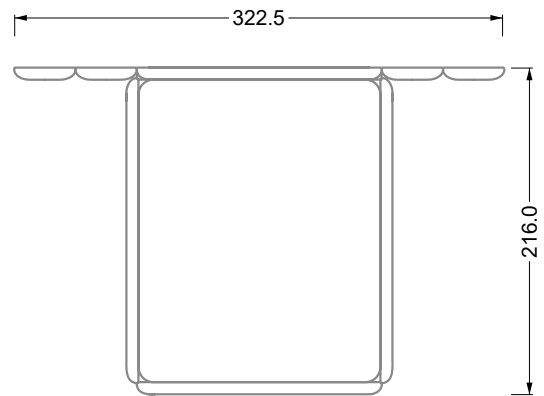
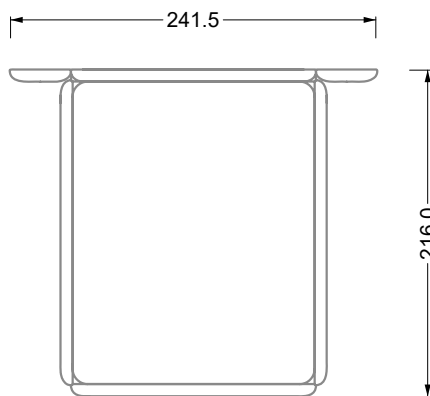
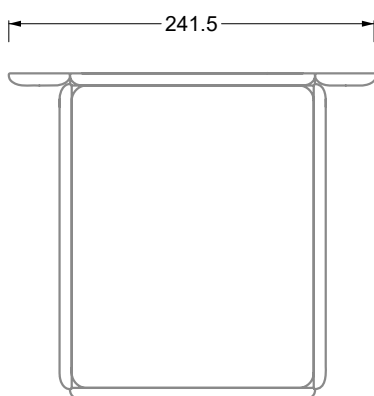
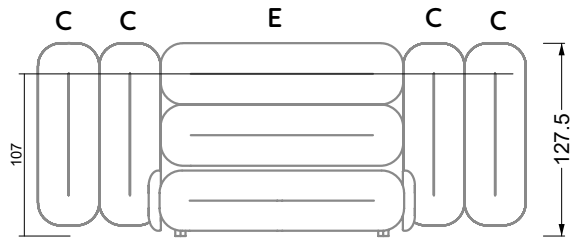
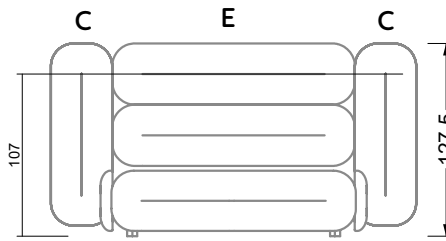
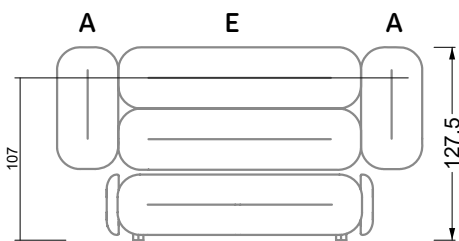
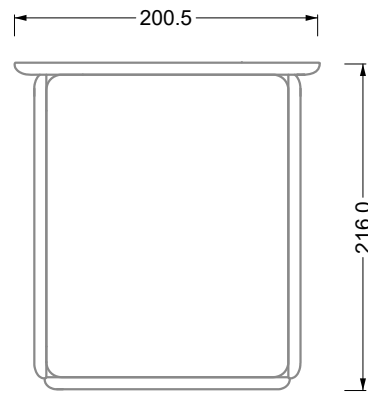
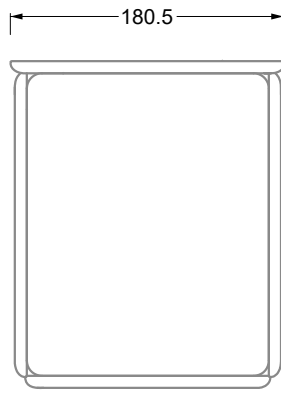
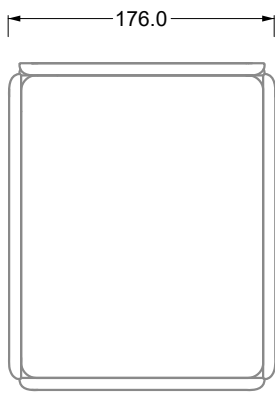
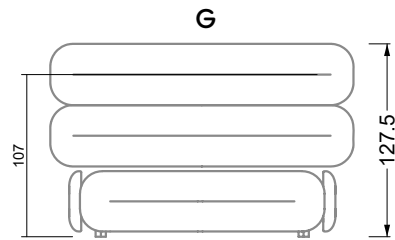
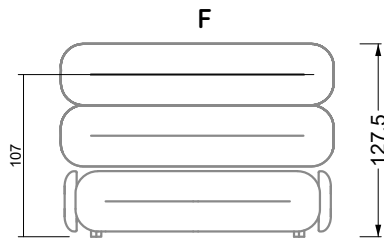
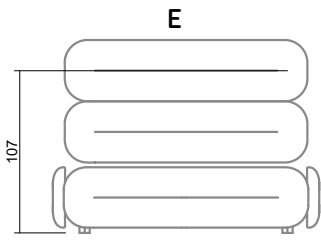

W 129-160

4-er

Breite: 176,0 cm

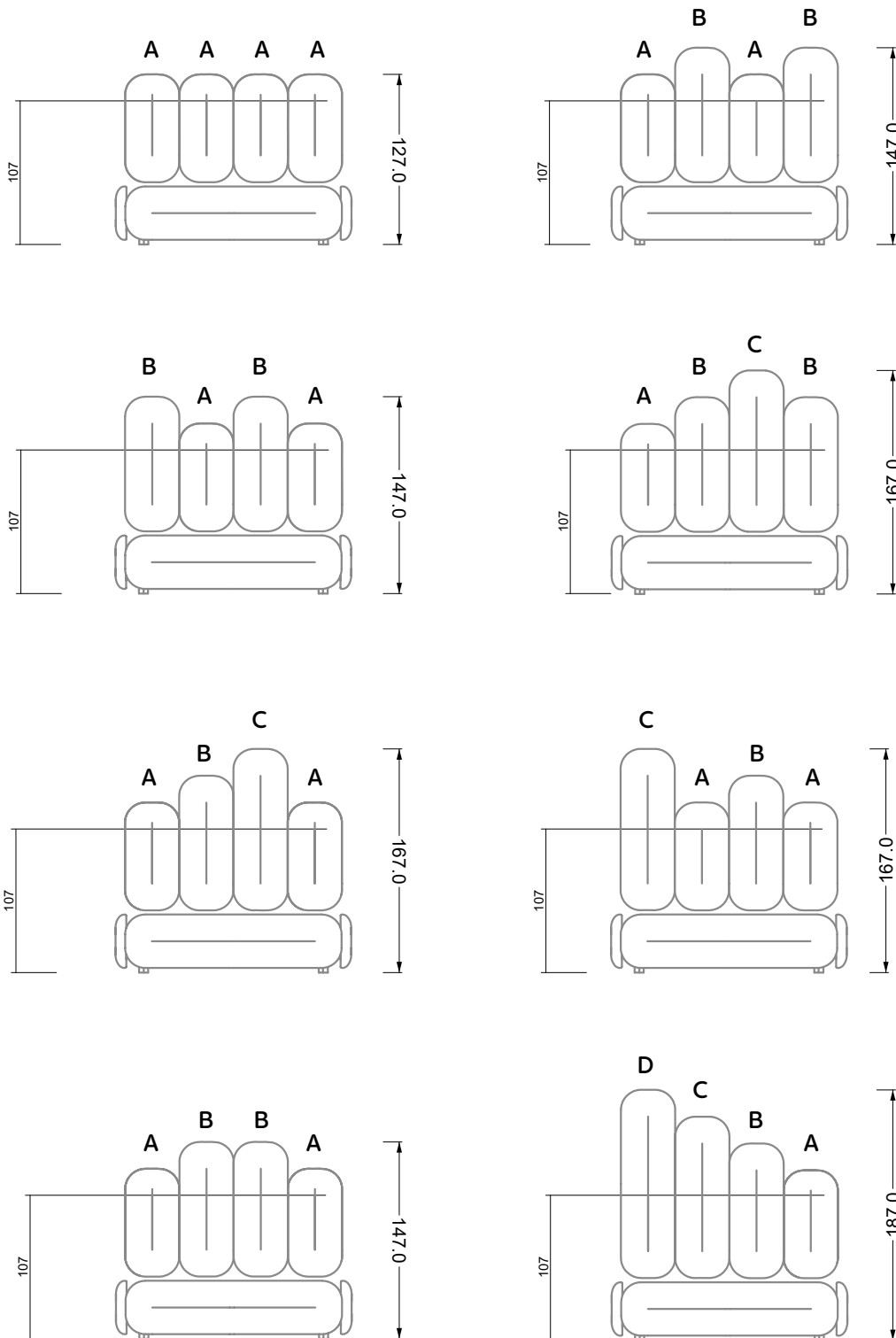

W 129-160

5-er

Breite: 202,5 cm

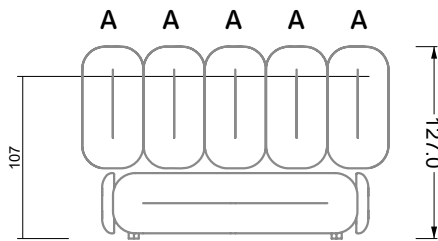

6-er

Breite: 243,0 cm

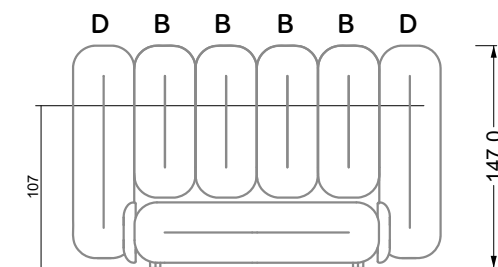
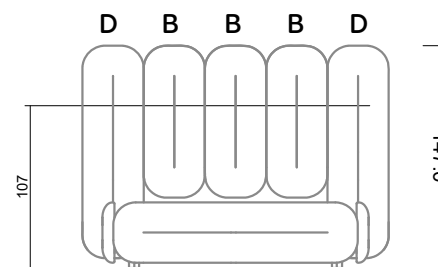
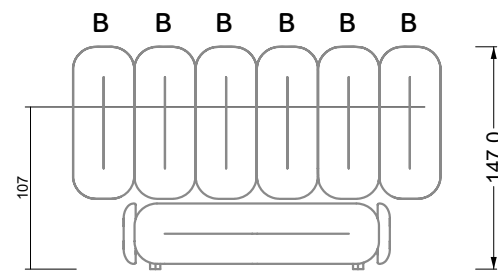
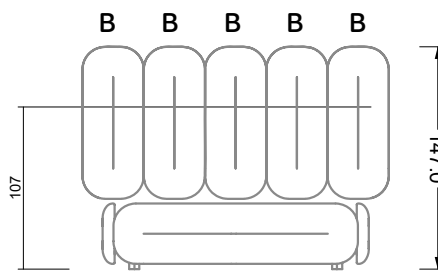
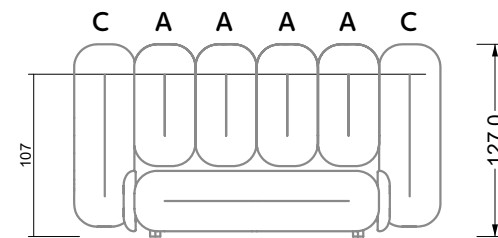
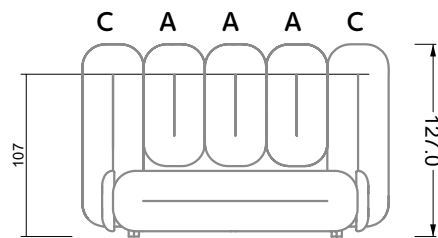
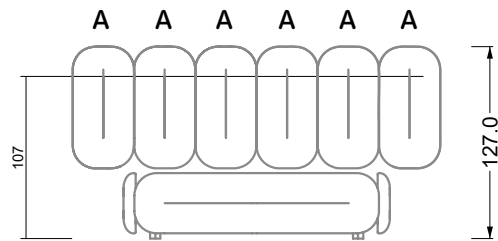

W 129-160

7-er

Breite: 283,5 cm

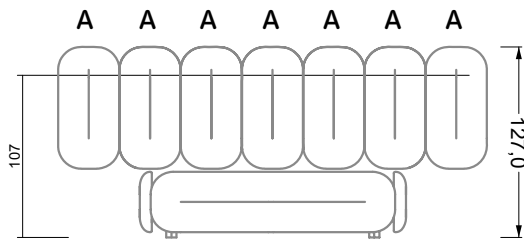

8-er

Breite: 324,0 cm

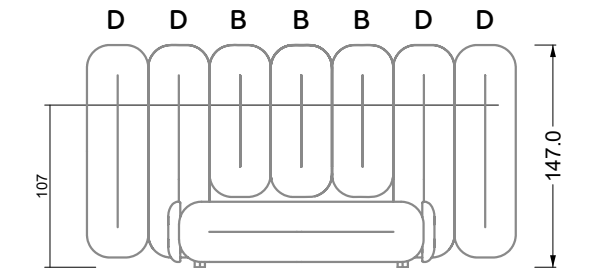
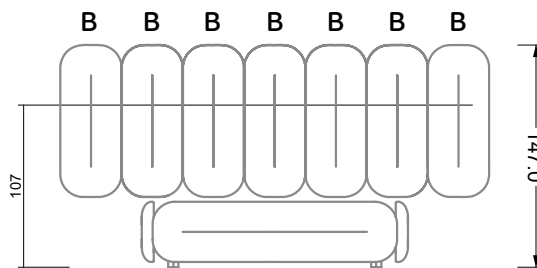
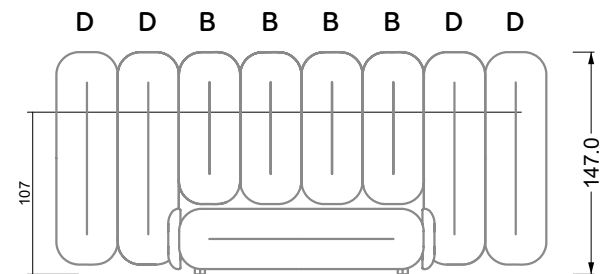
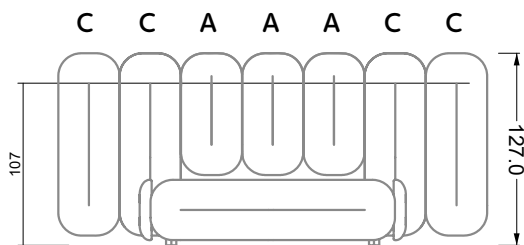
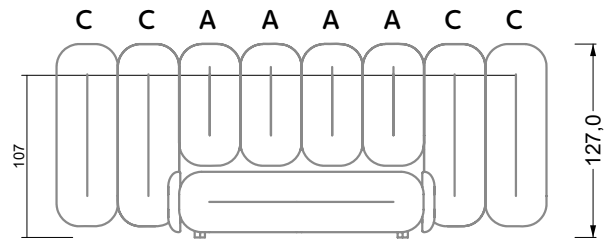

9-er

Breite: 364,5 cm

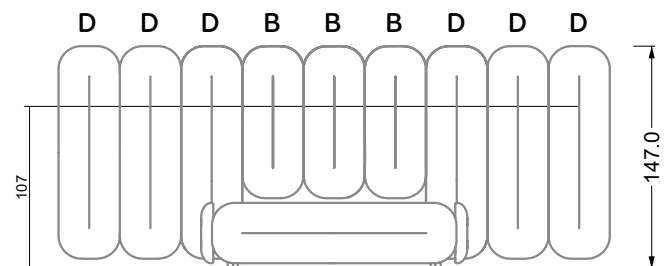
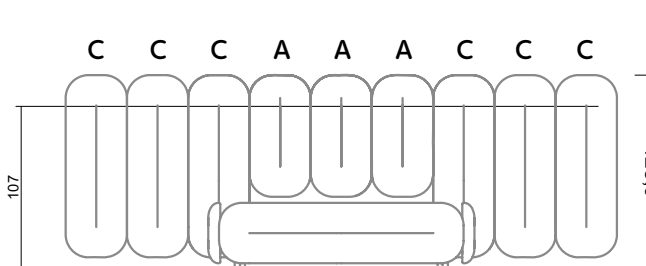

W 129-160

5-er

Breite: 202,5 cm

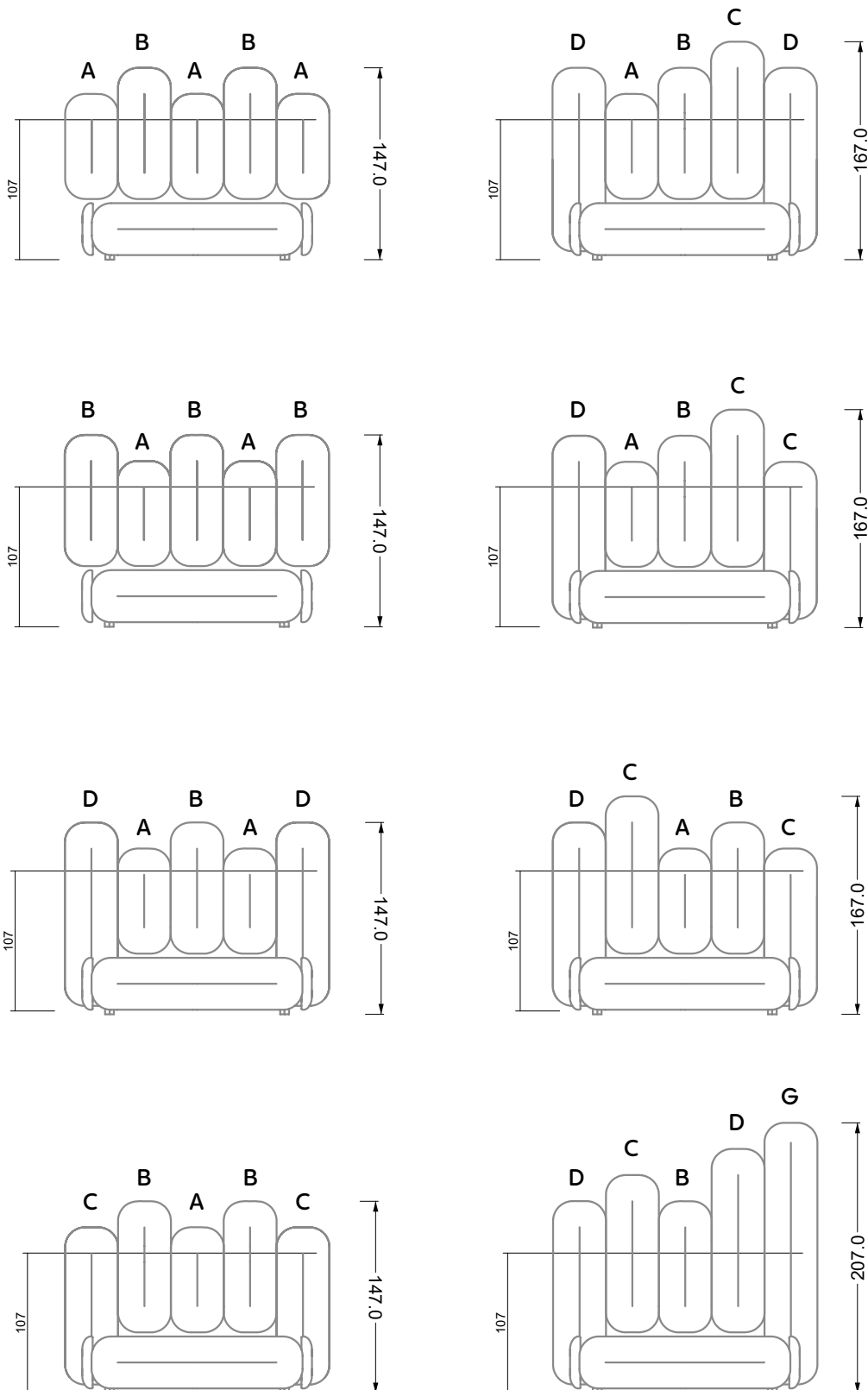

W 129-160

6-er

Breite: 243,0 cm

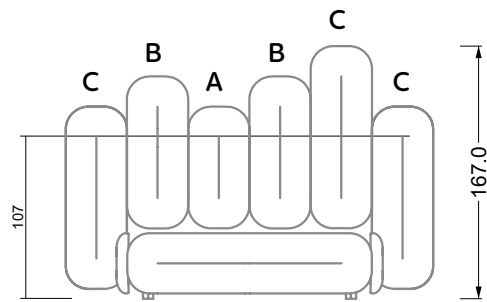
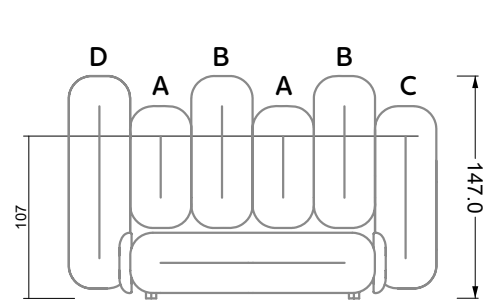
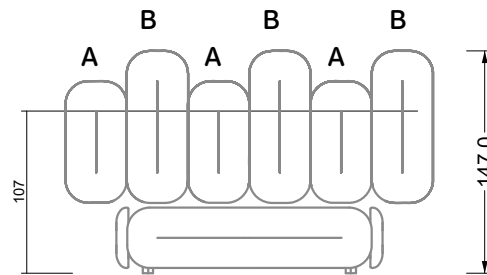
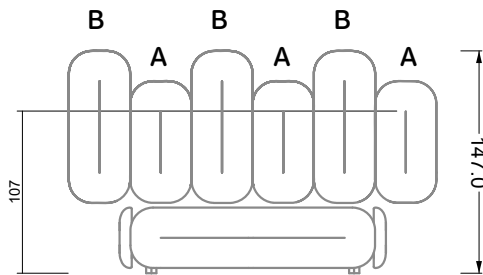

SET 1.3

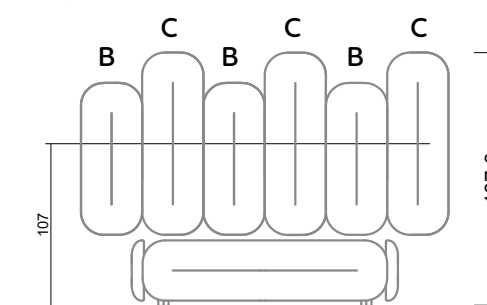
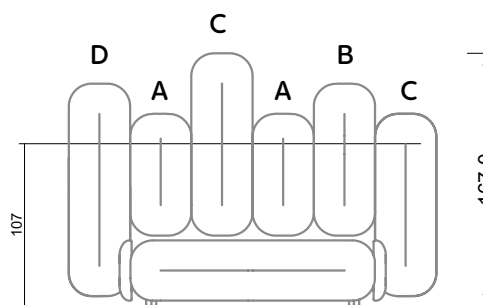
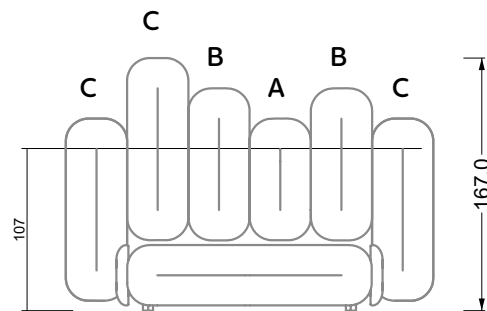
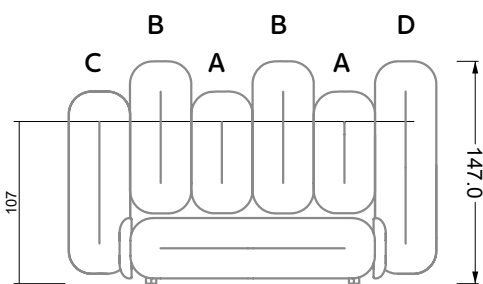

W 129-160

7-er

Breite: 283,5 cm

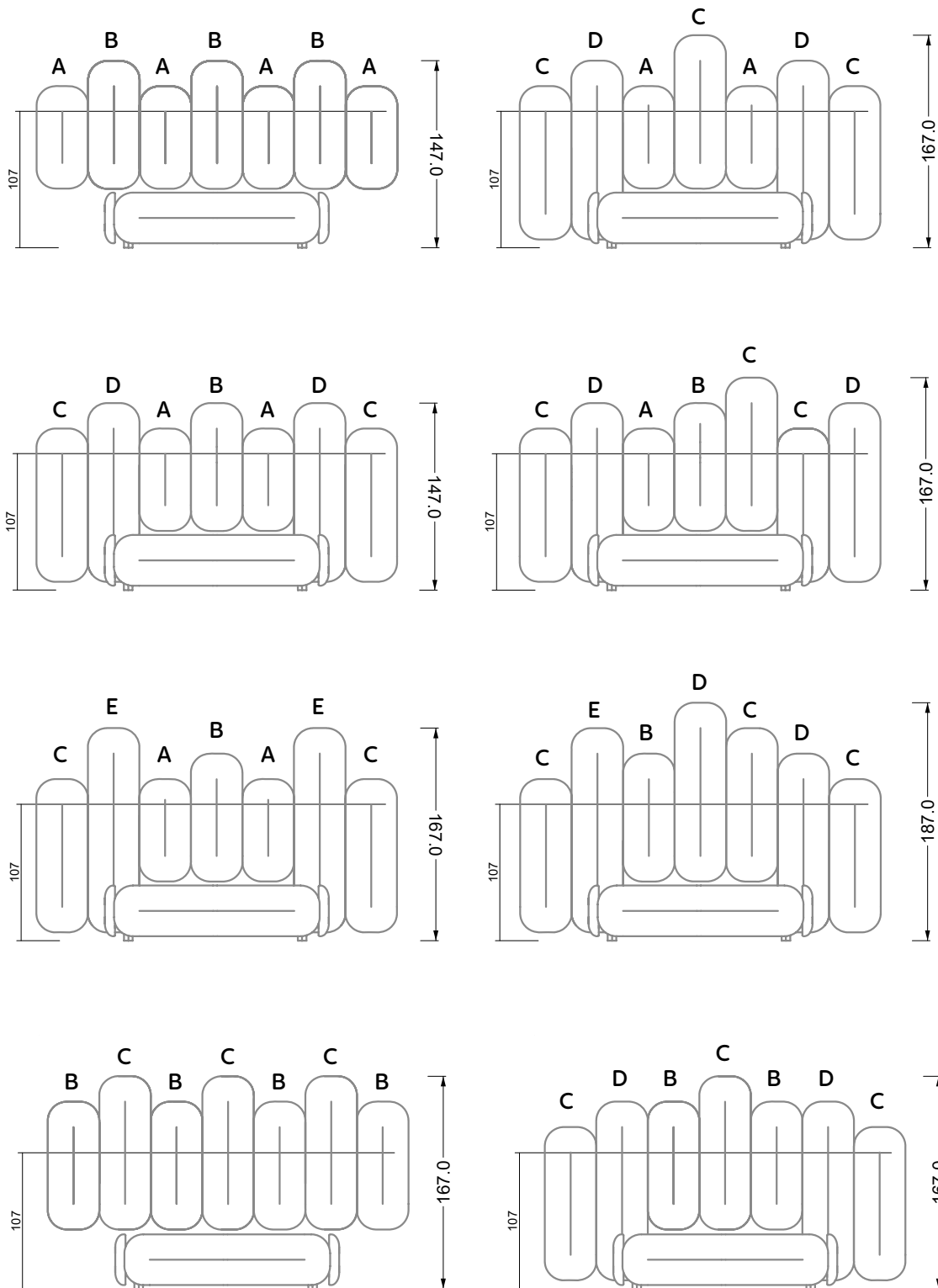

W 129-160

8-er

Breite: 324,0 cm

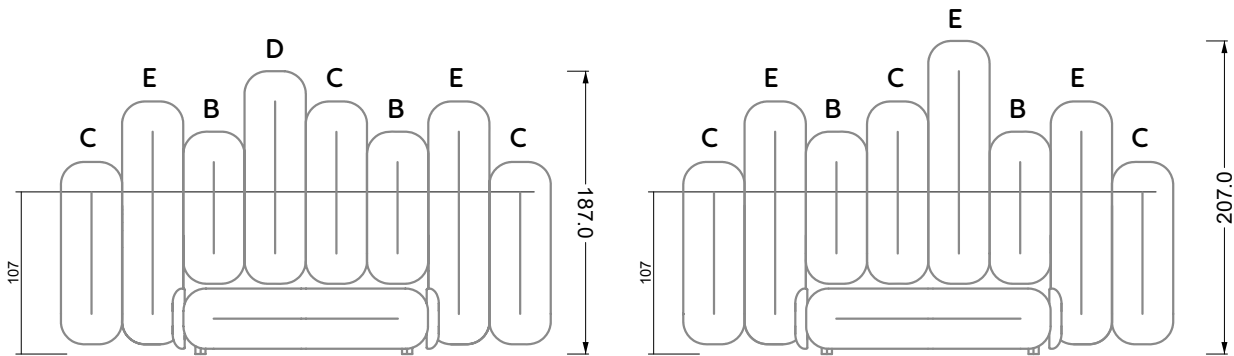
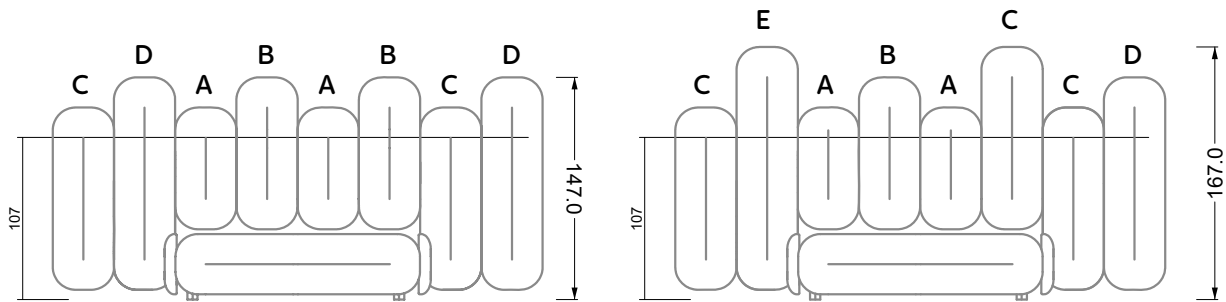

9-er

Breite: 364,5 cm

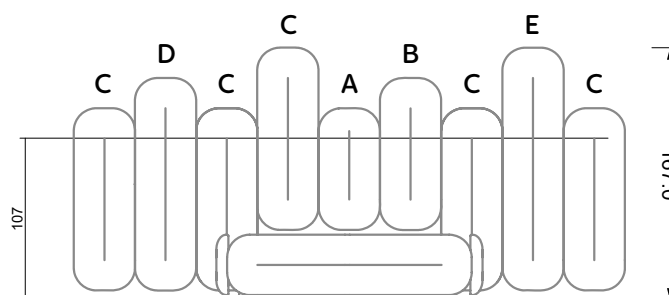
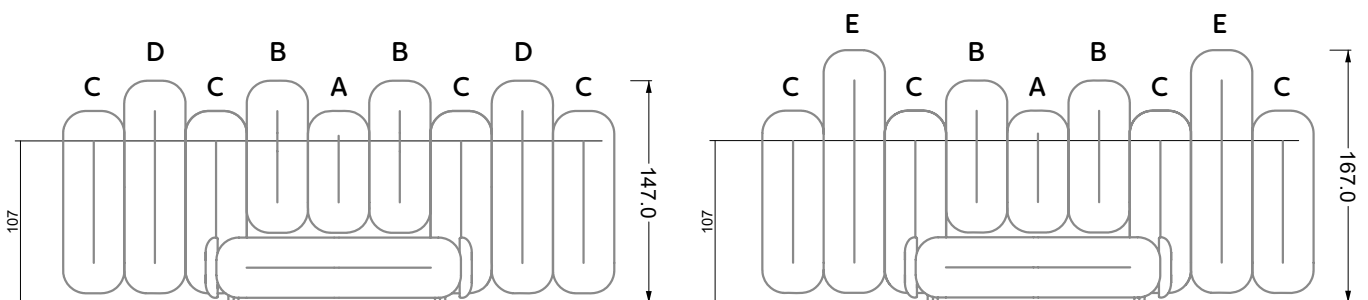

W 129-160

5-er
Breite: 202,5 cm

6-er
Breite: 243,0 cm

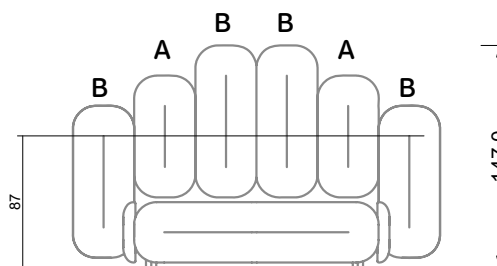
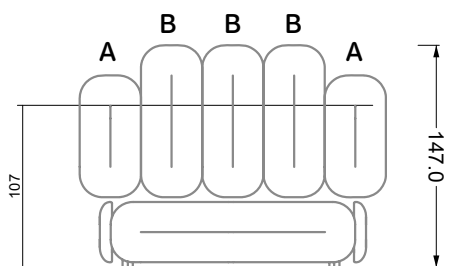
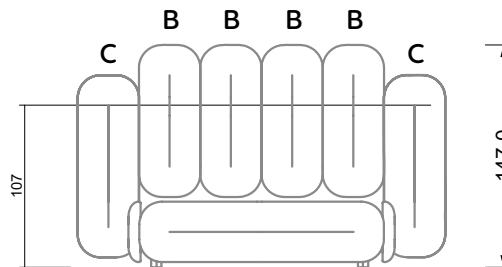
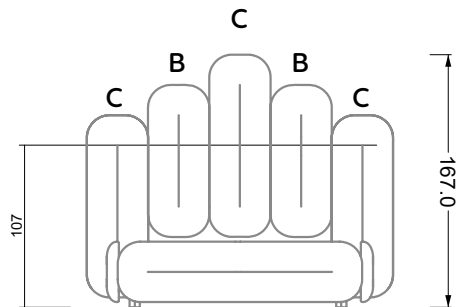

SET 2.3

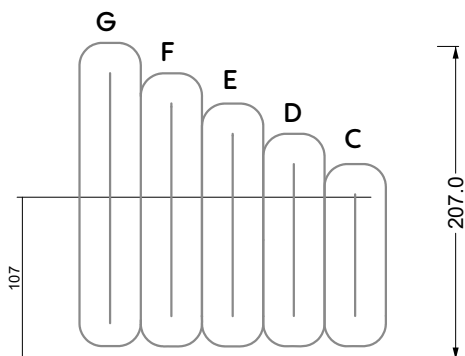
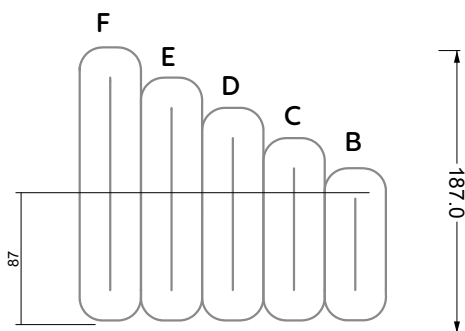
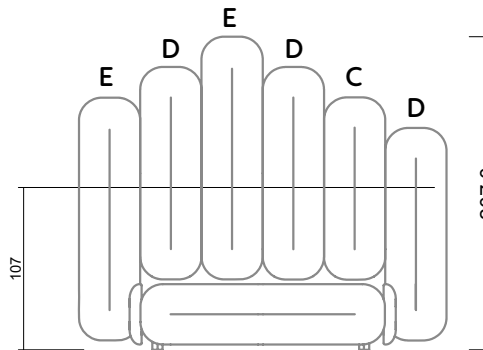
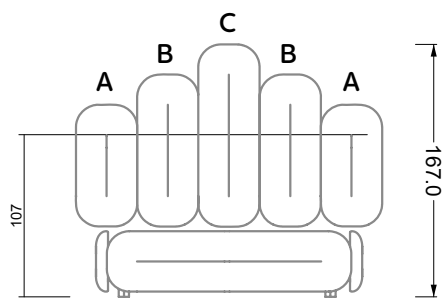

W 129-160

7-er

Breite: 283,5 cm

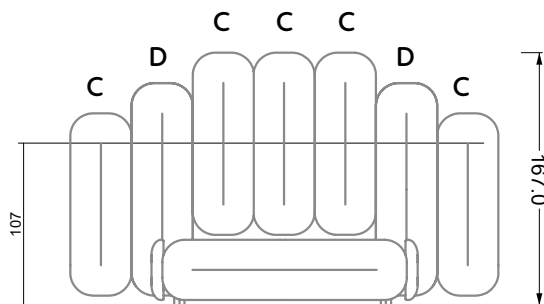
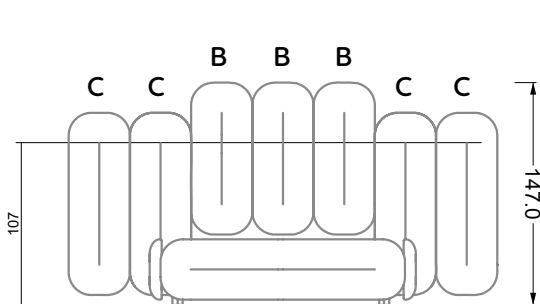

8-er

Breite: 324,0 cm

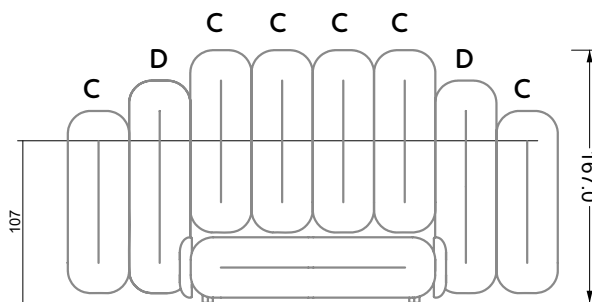
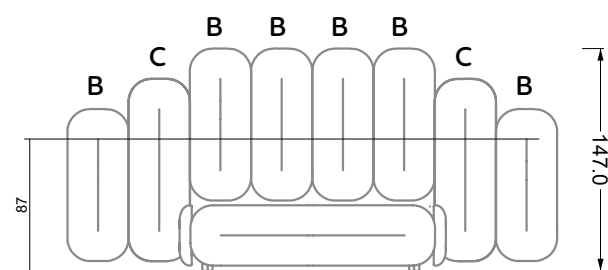
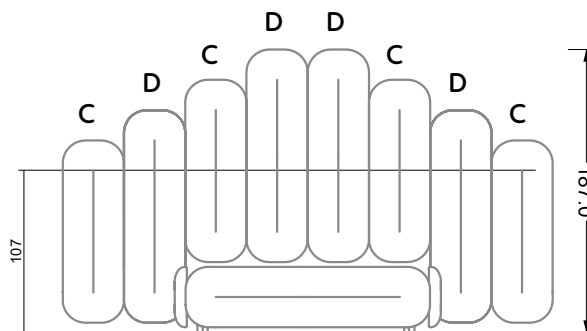
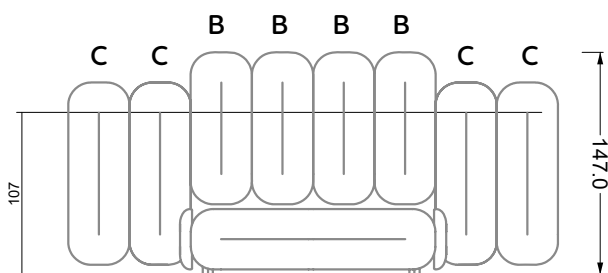

9-er

Breite: 364,5 cm

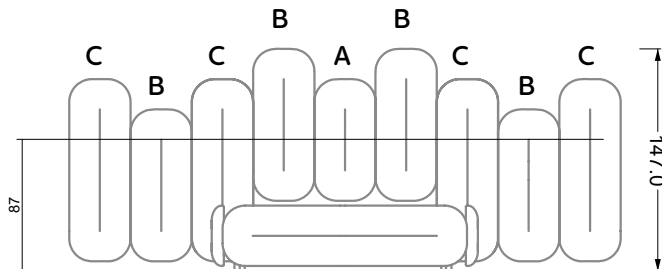
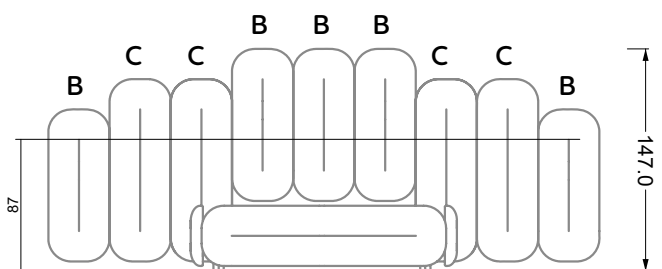

W 129-180

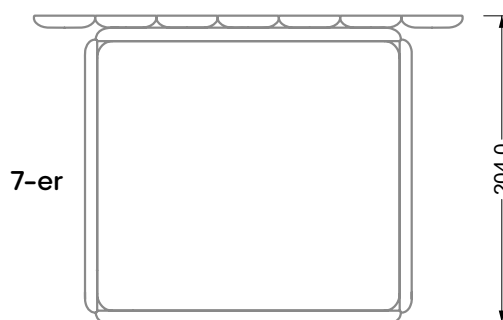
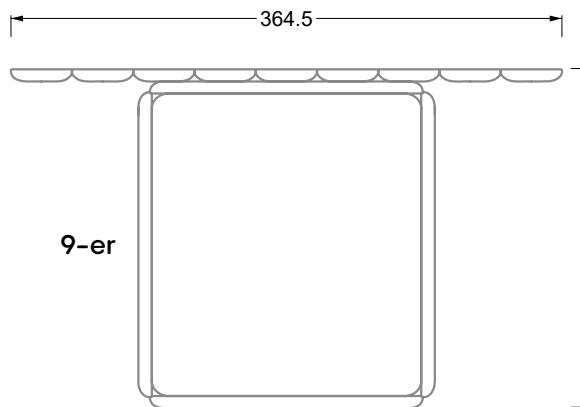
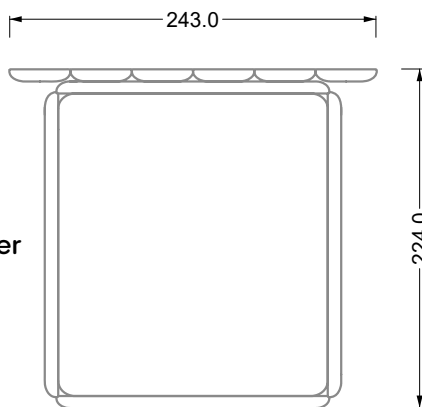
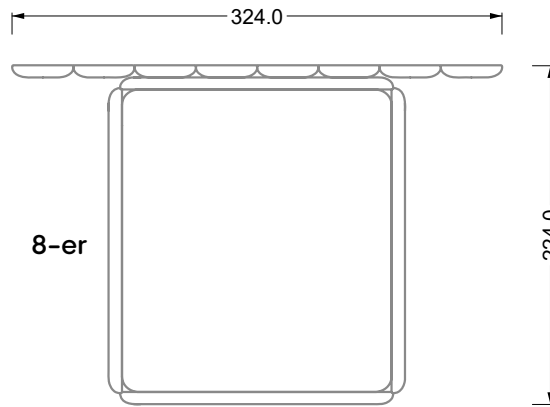
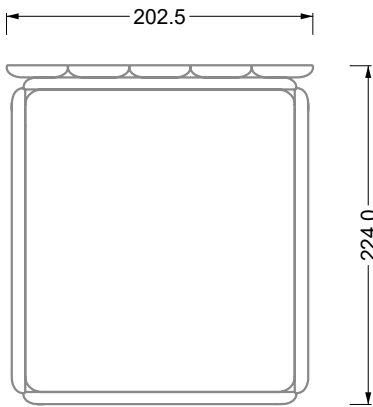
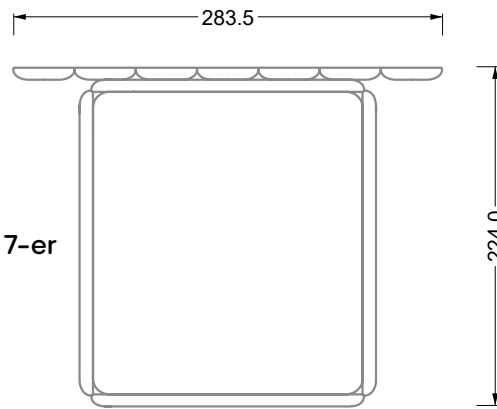
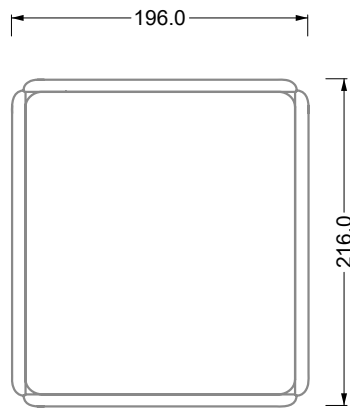

Bettkasten um
90 Grad gedreht

W 129-180

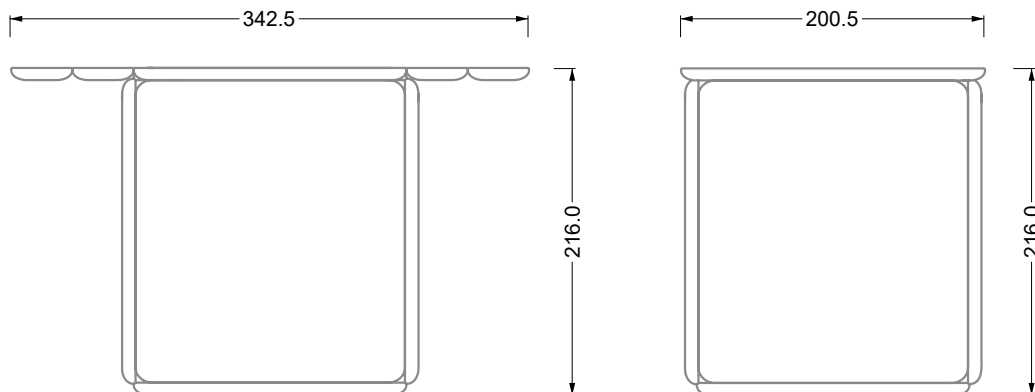
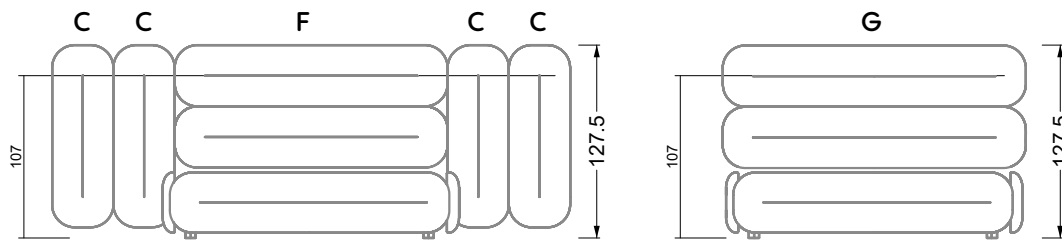
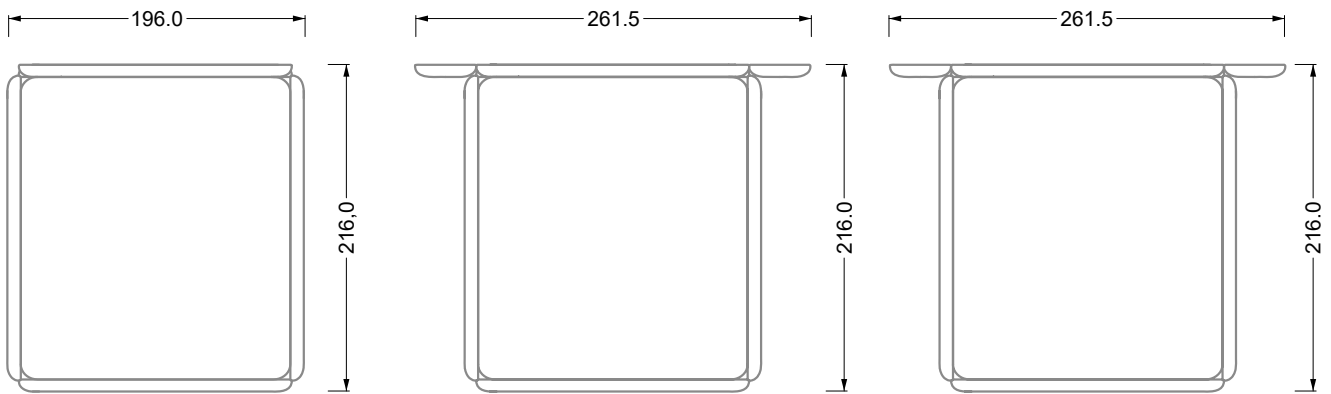
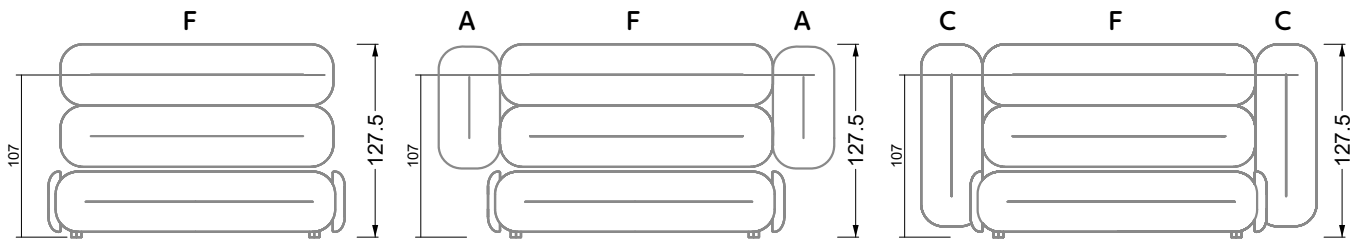

W 129-180

5-er

Breite: 202,5 cm

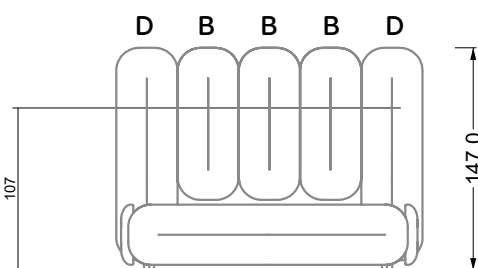
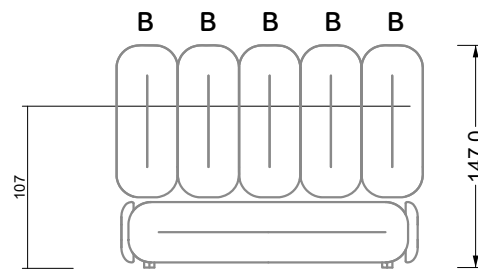
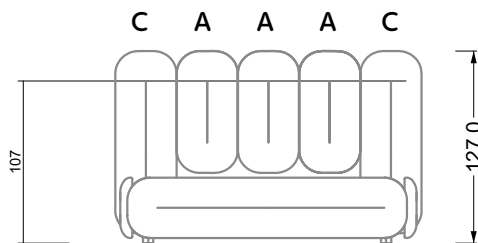
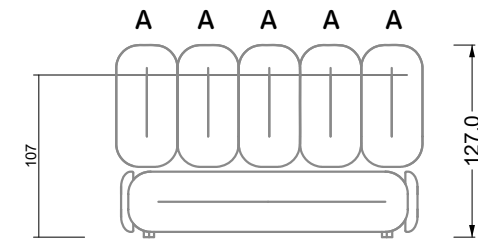

6-er

Breite: 243,0 cm

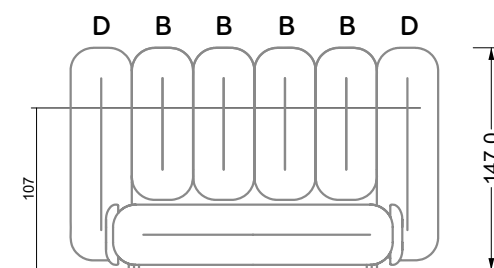
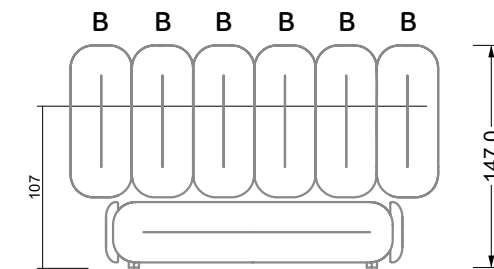
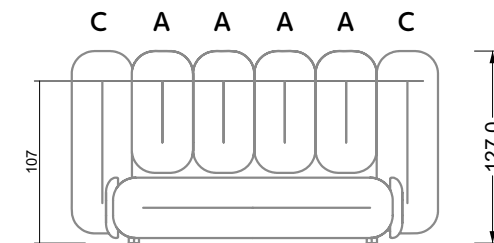
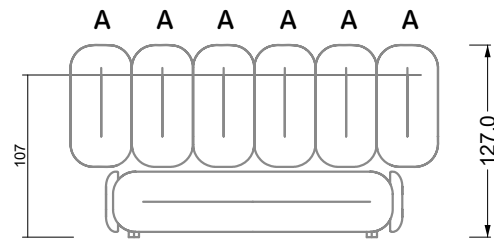

W 129-180

7-er

Breite: 283,5 cm

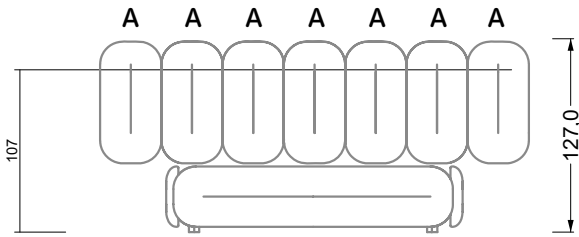

8-er

Breite: 324,0 cm

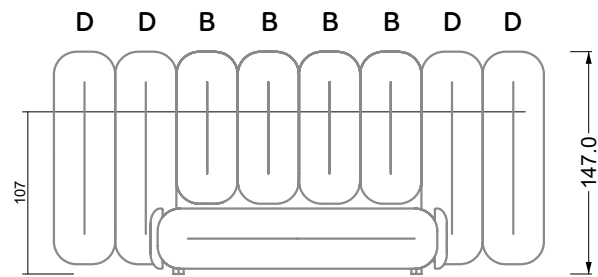
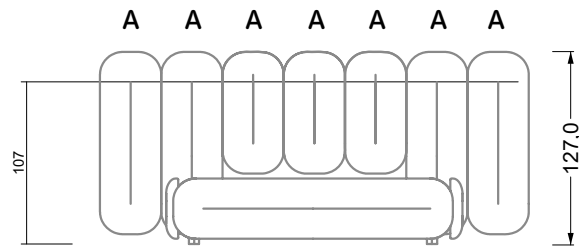
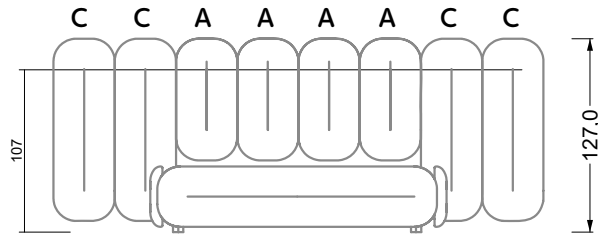

9-er

Breite: 364,5 cm

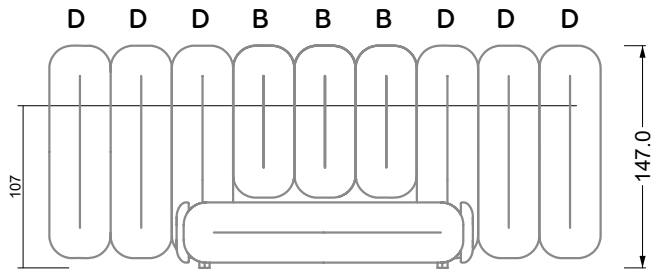
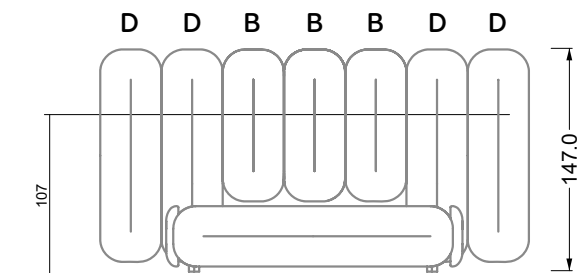
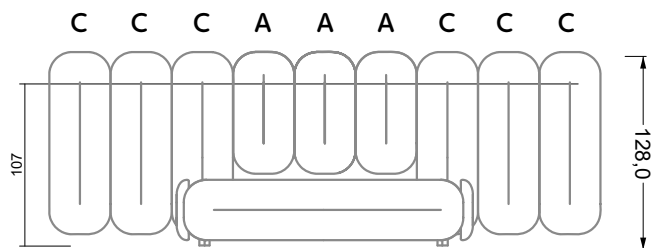
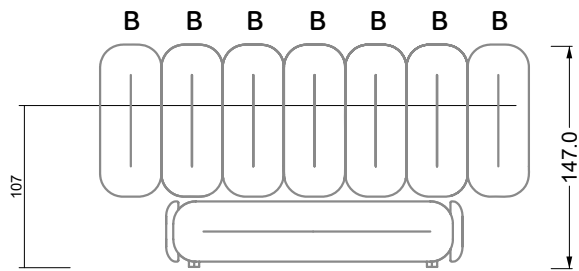

W 129-180

5-er

Breite: 202,5 cm

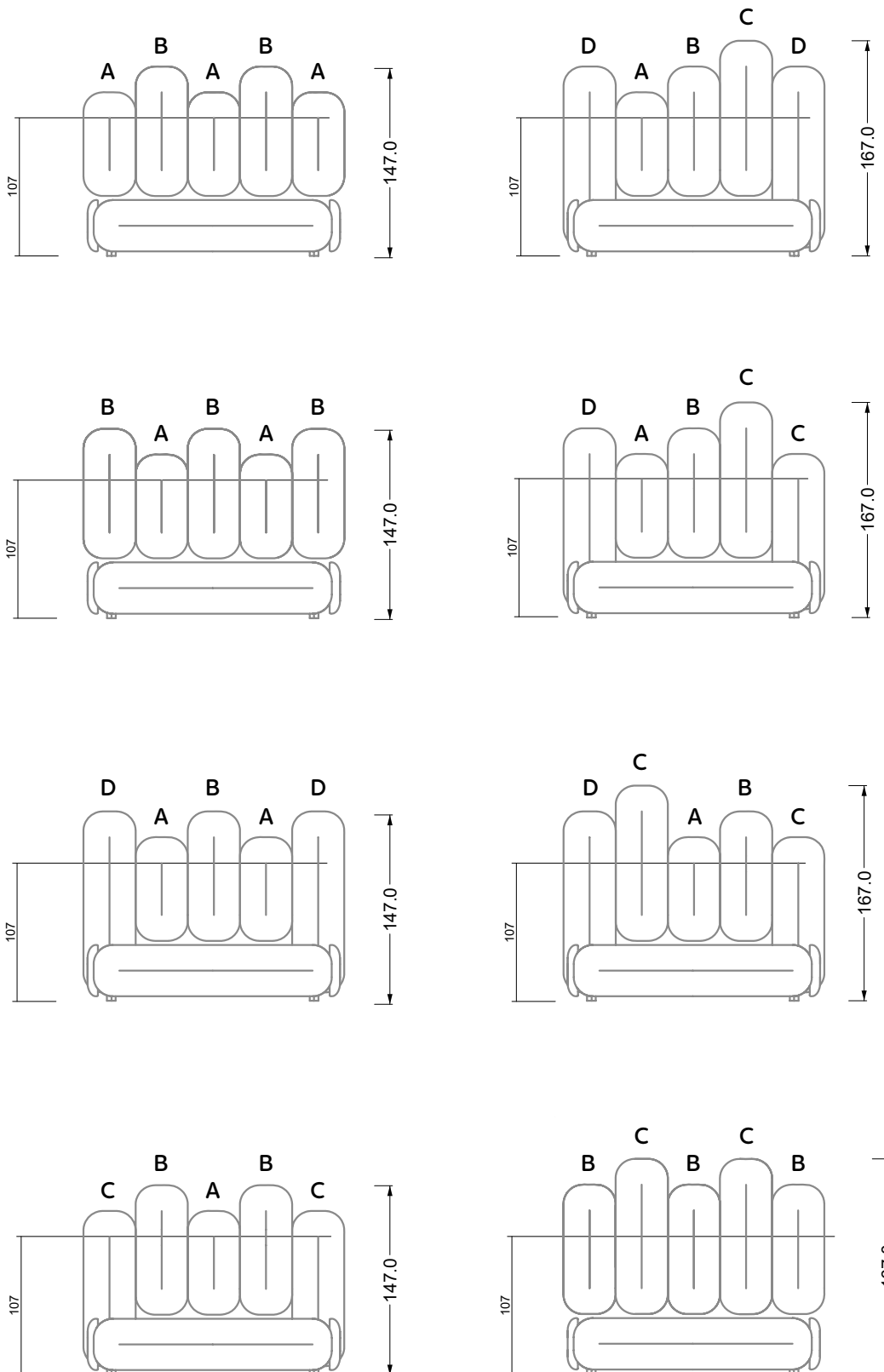

W 129-180

6-er

Breite: 243,0 cm

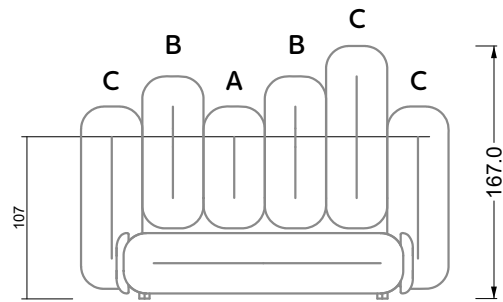
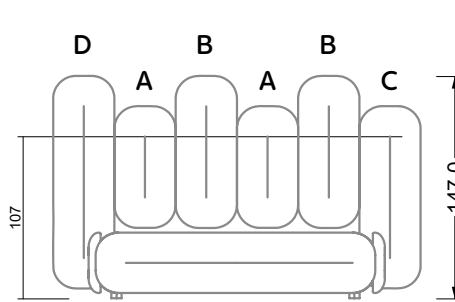
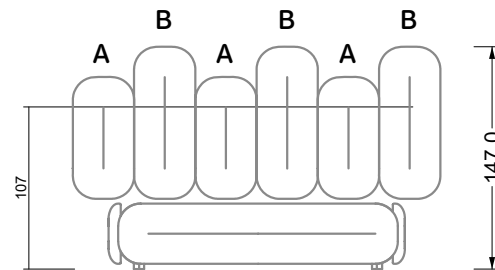
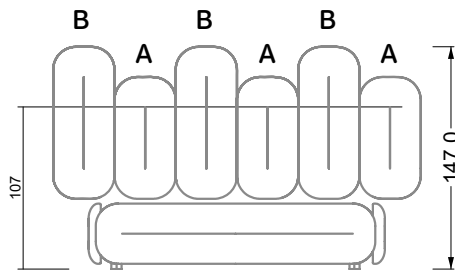

SET 1.2

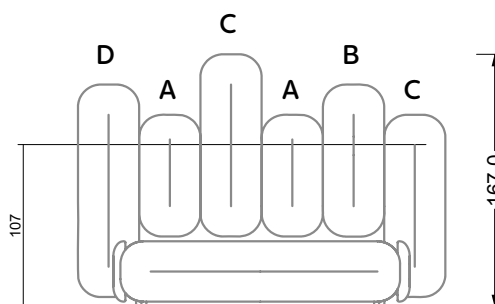
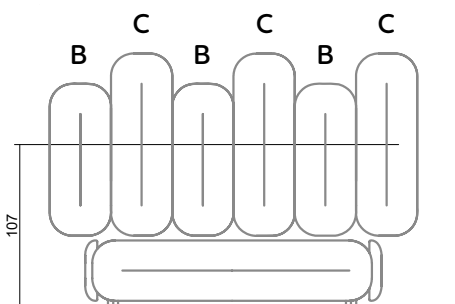
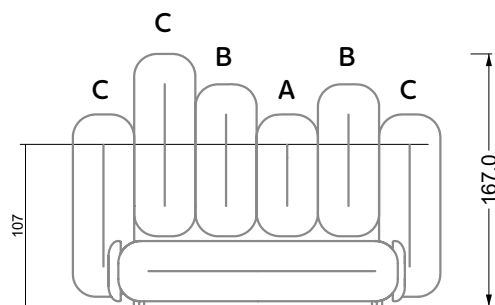
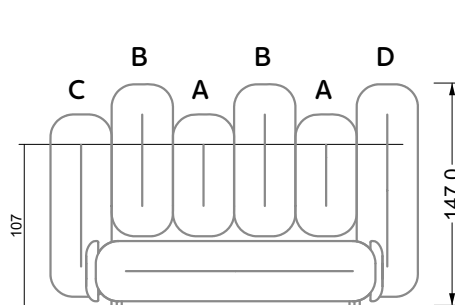

W 129-180

7-er

Breite: 283,5 cm

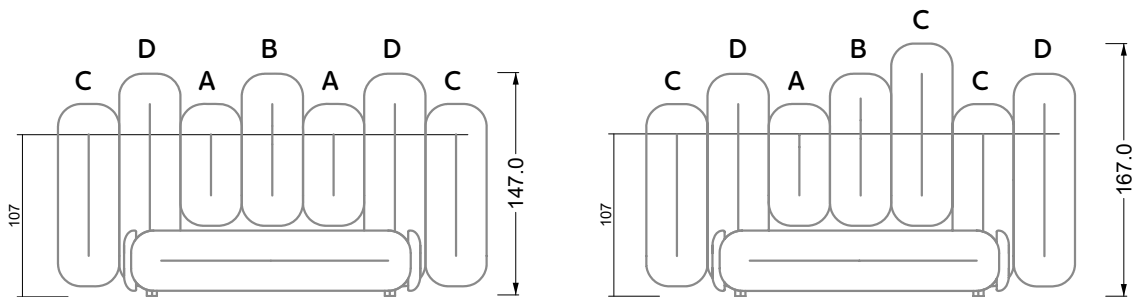
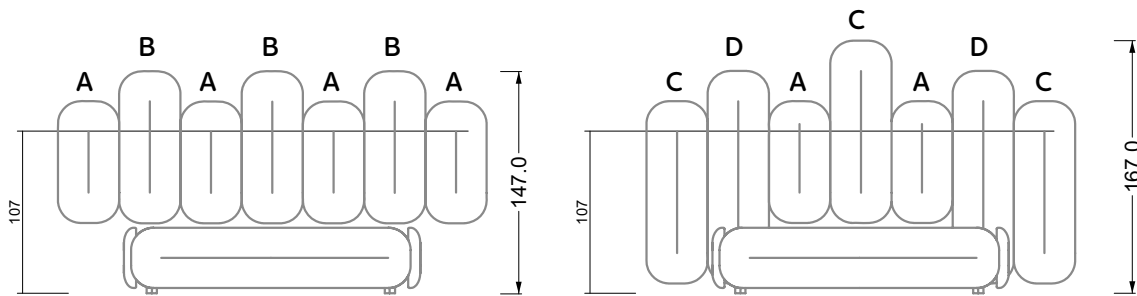

SET 3

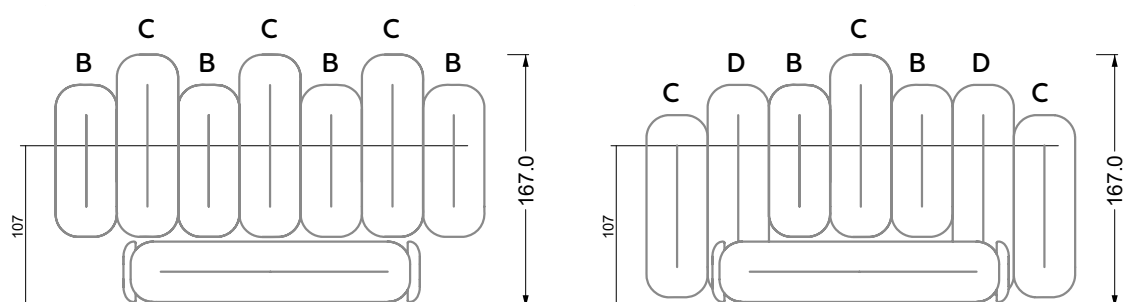
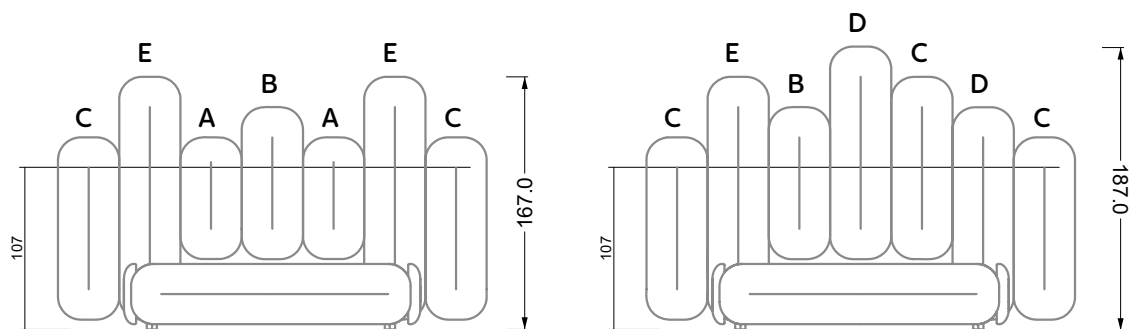

W 129-180

8-er

Breite: 324,0 cm

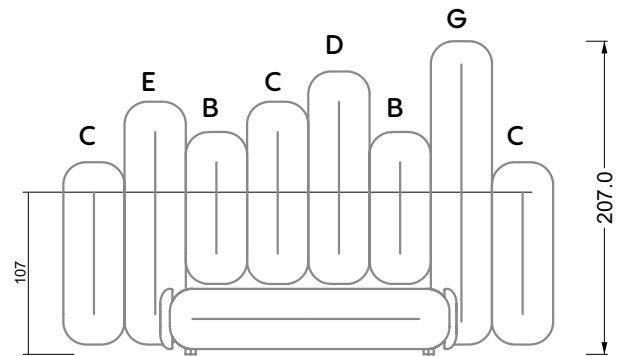
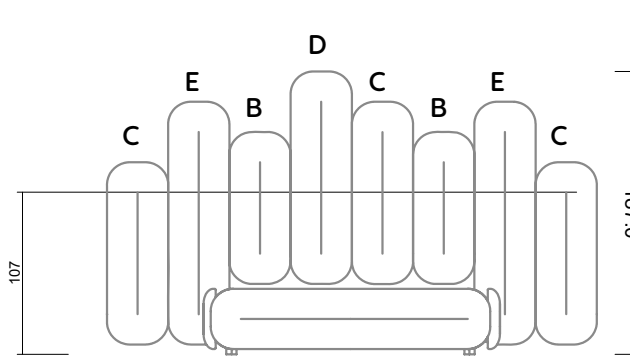
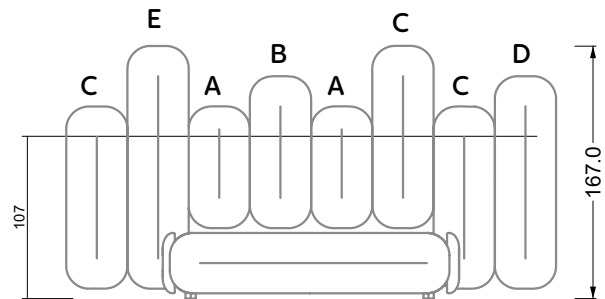
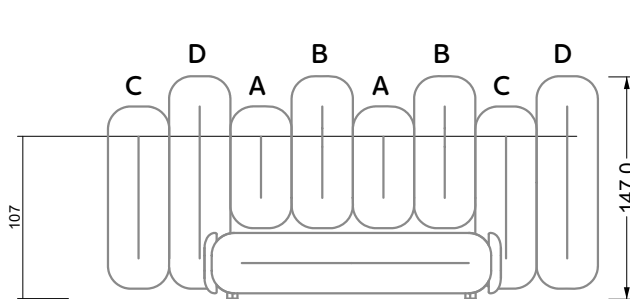

9-er

Breite: 364,5 cm

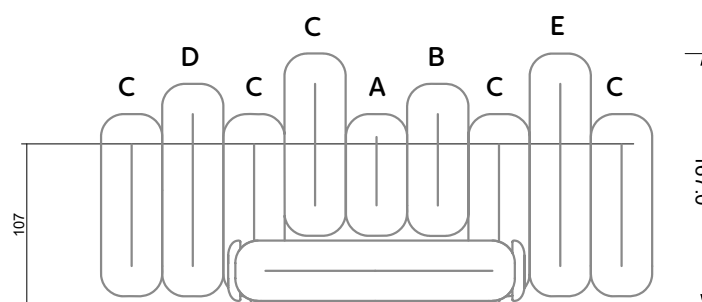
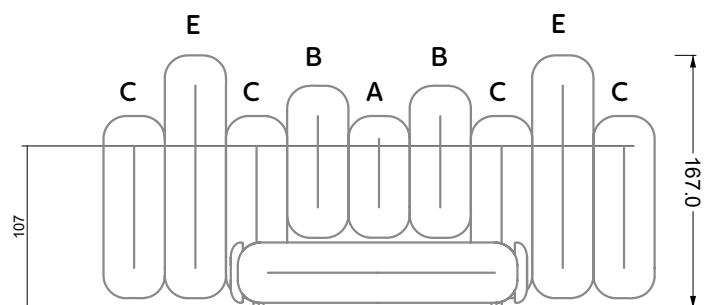
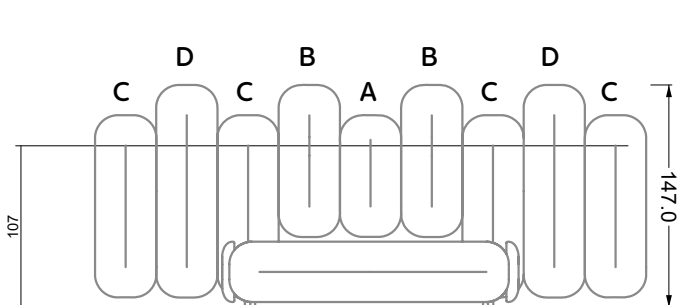

W 129-180

5-er

Breite: 202,5 cm

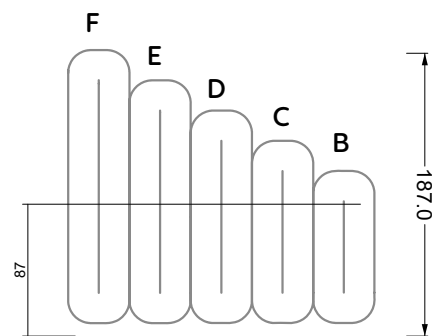
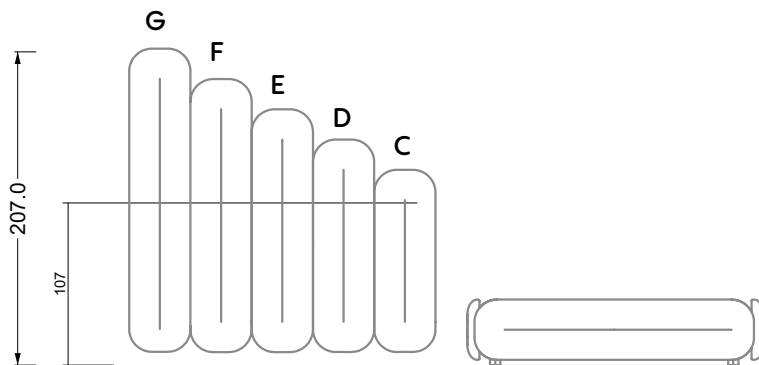
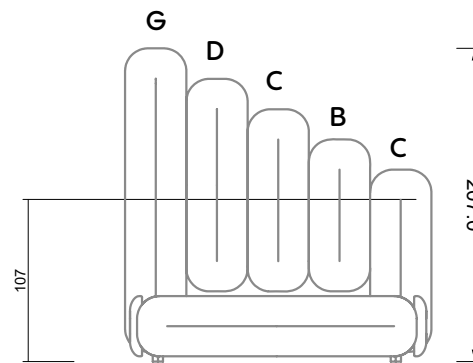
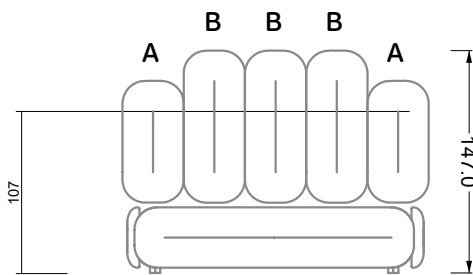
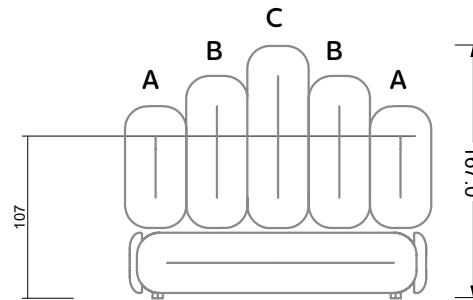
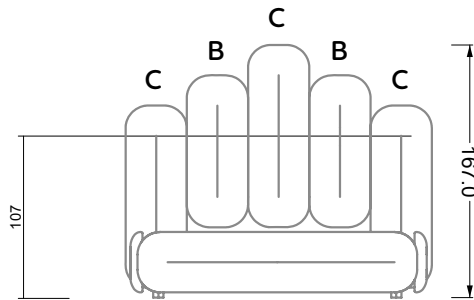

6-er

Breite: 243,0 cm

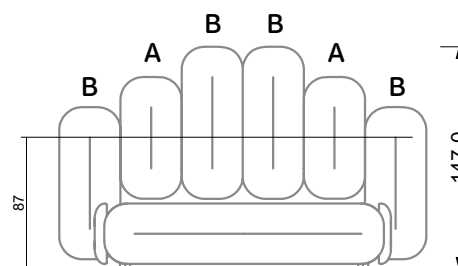
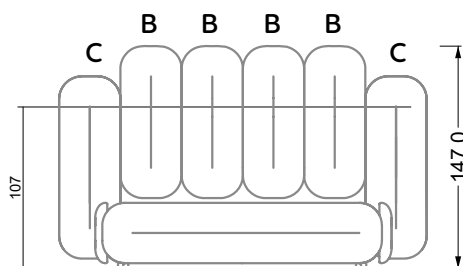

SET 2.2

W 129-180

7-er

Breite: 283,5 cm

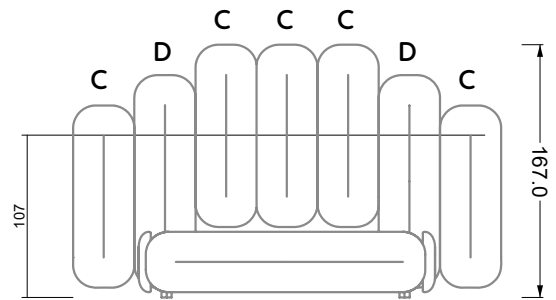
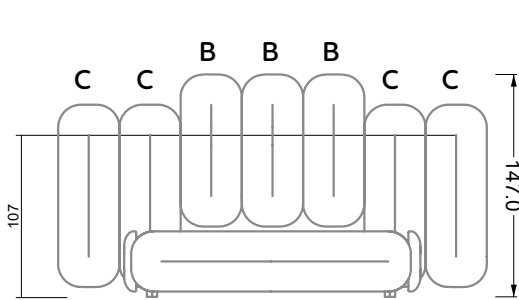

8-er

Breite: 324,0 cm

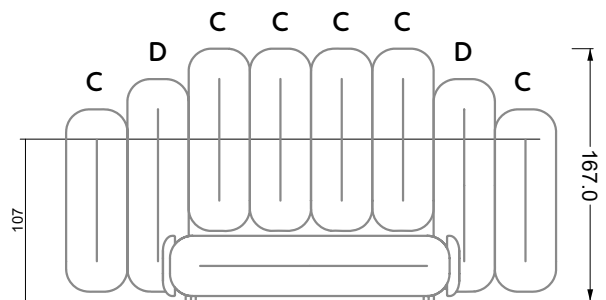
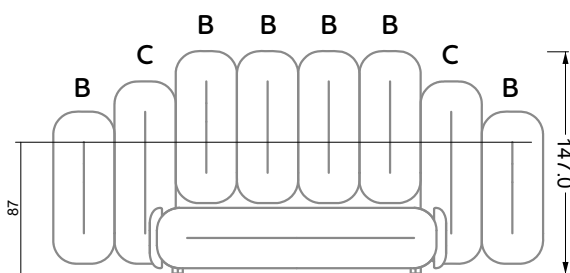
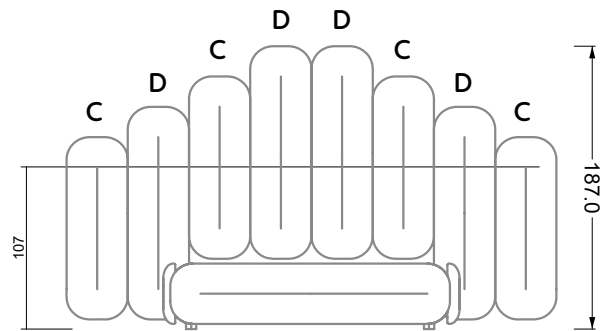
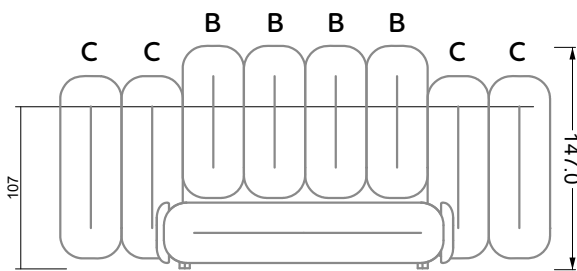

9-er

Breite: 364,5 cm

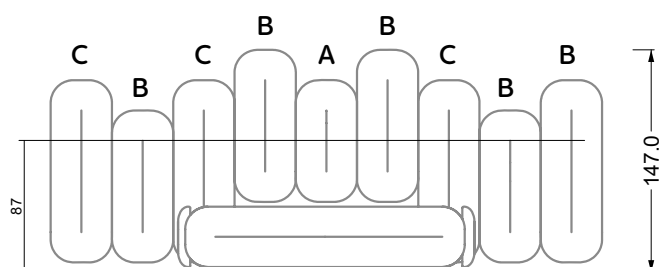
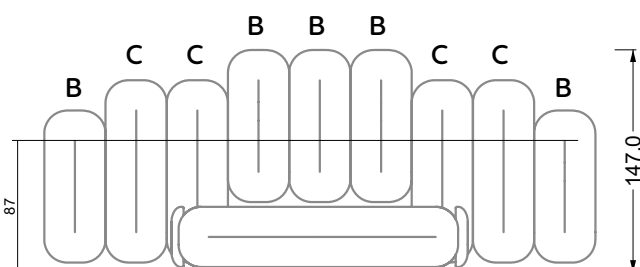

W 129-200

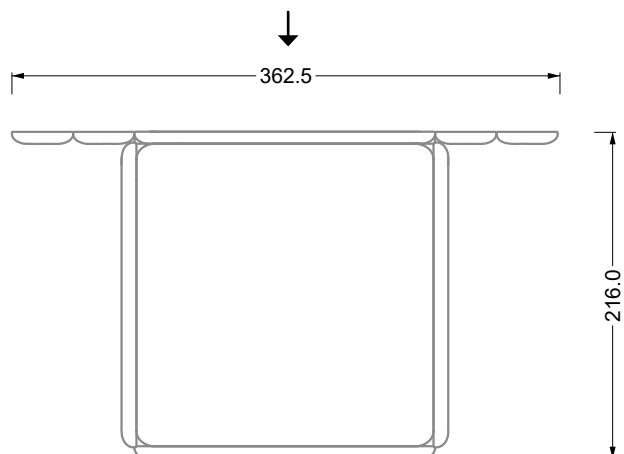
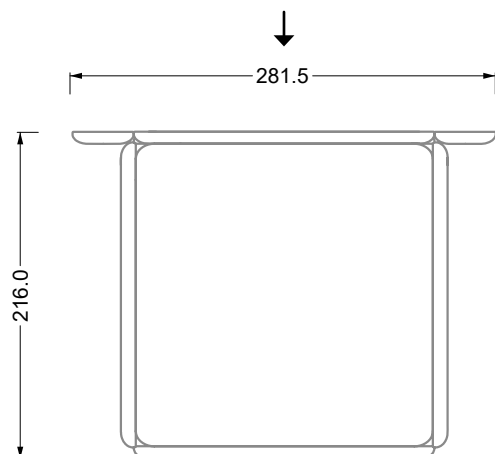
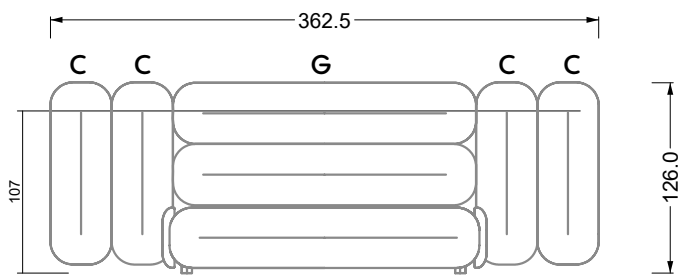
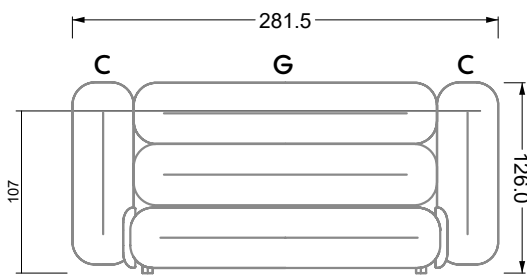
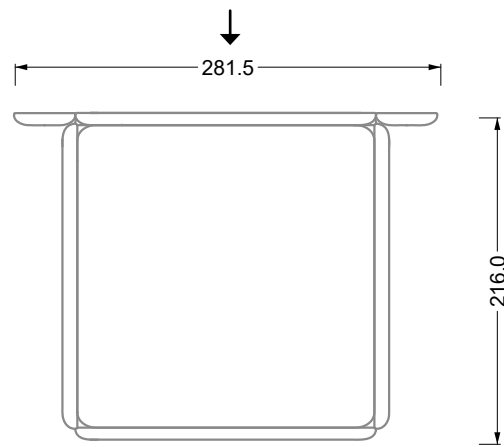
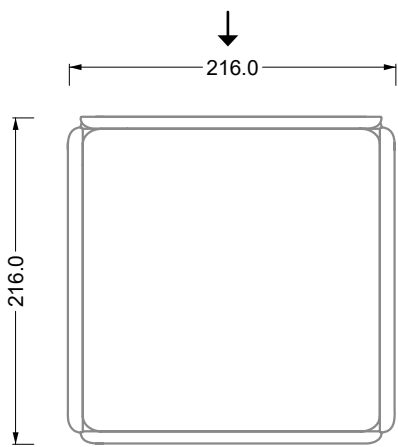
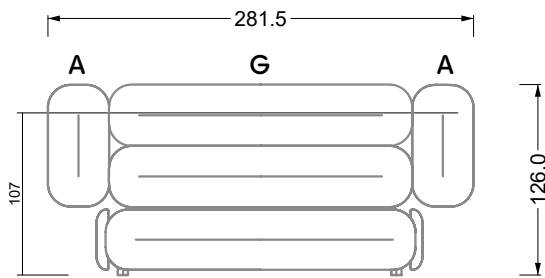
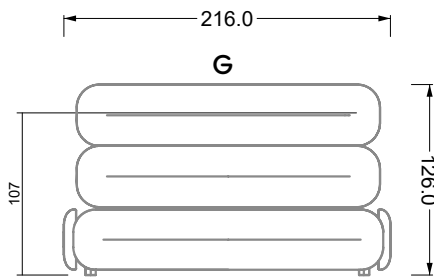

W 129-200

5-er

Breite: 202,5 cm

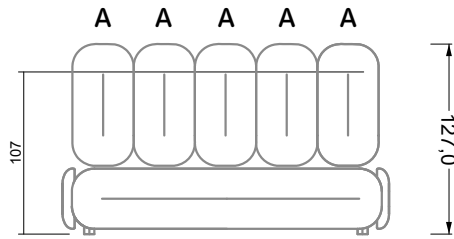

6-er

Breite: 243,0 cm

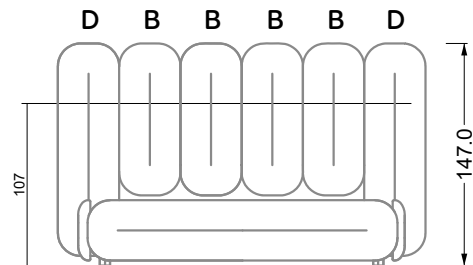
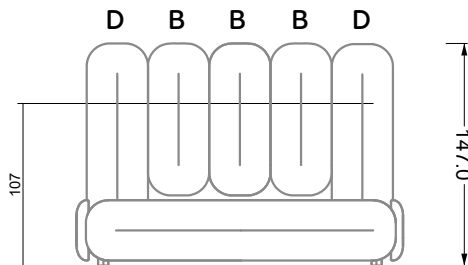
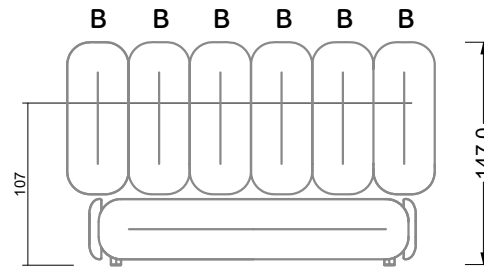
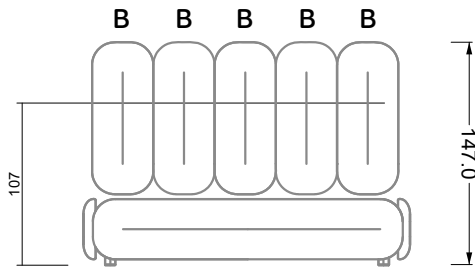
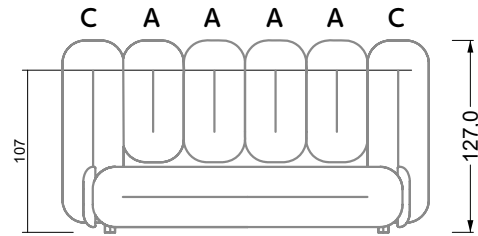
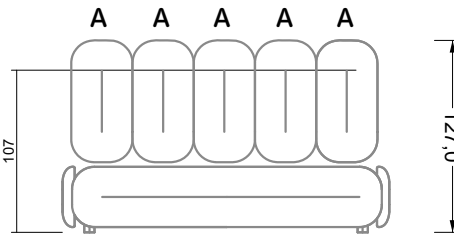
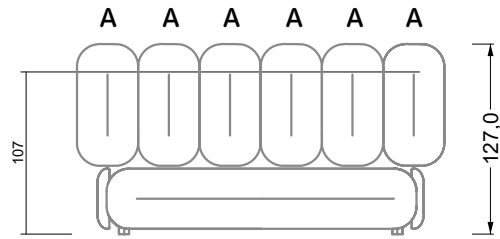

W 129-200

7-er

Breite: 283,5 cm

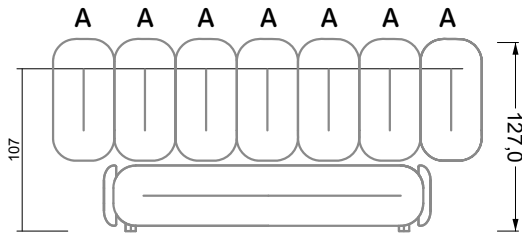

8-er

Breite: 324,0 cm

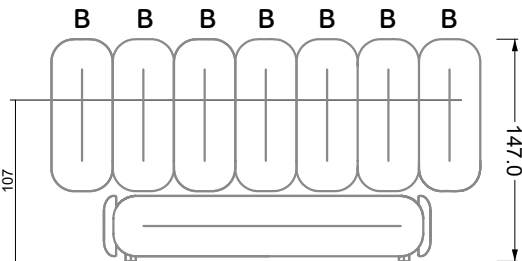
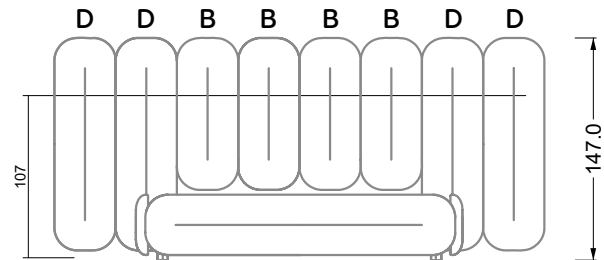
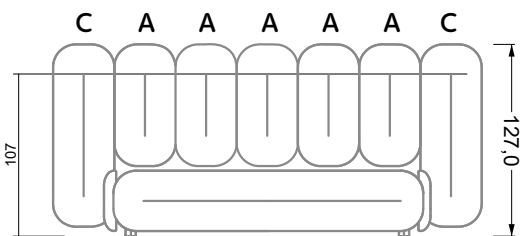
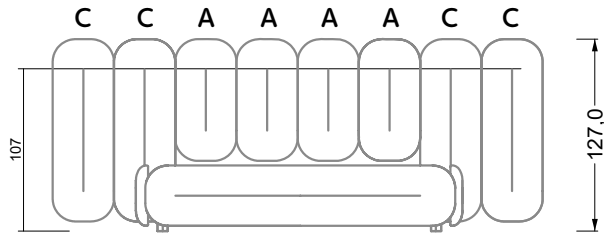

9-er

Breite: 364,5 cm

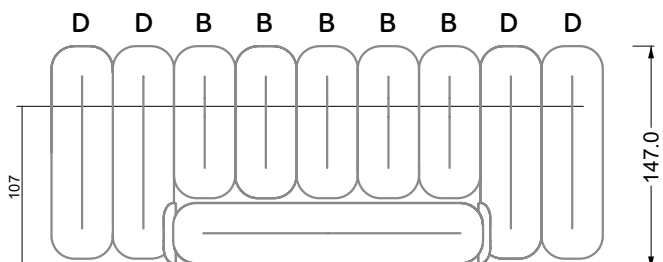
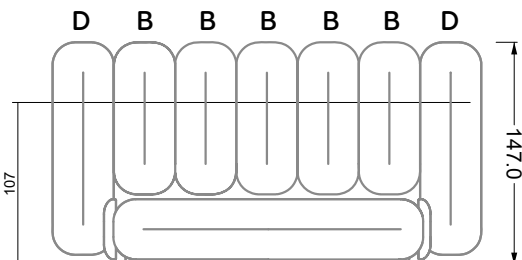
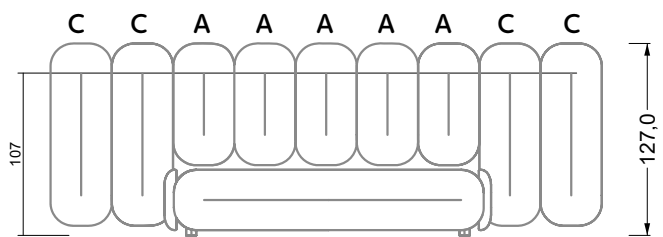

W 129-200

5-er

Breite: 202,5 cm

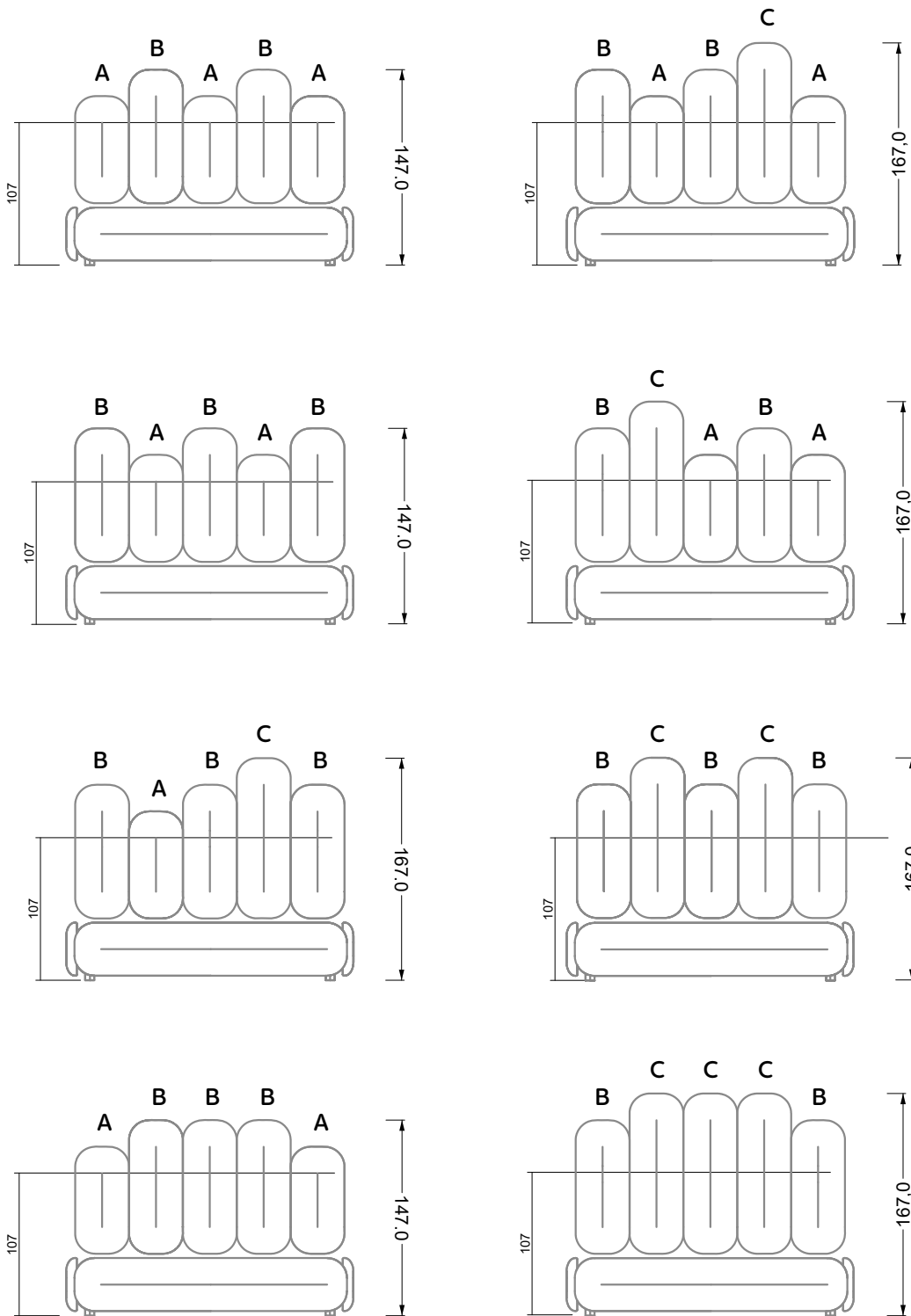

W 129-200

6-er

Breite: 243,0 cm

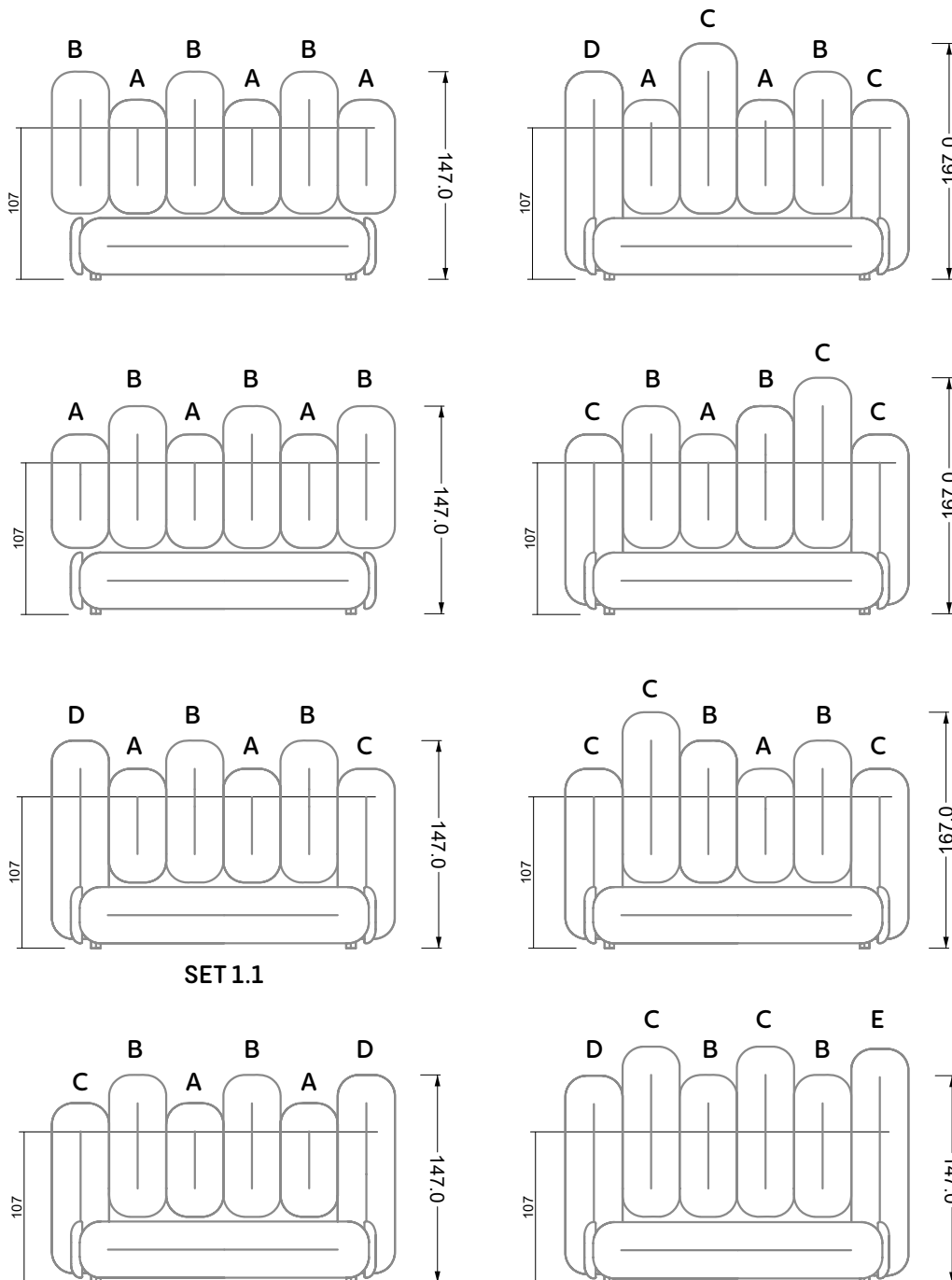

W 129-200

7-er

Breite: 283,5 cm

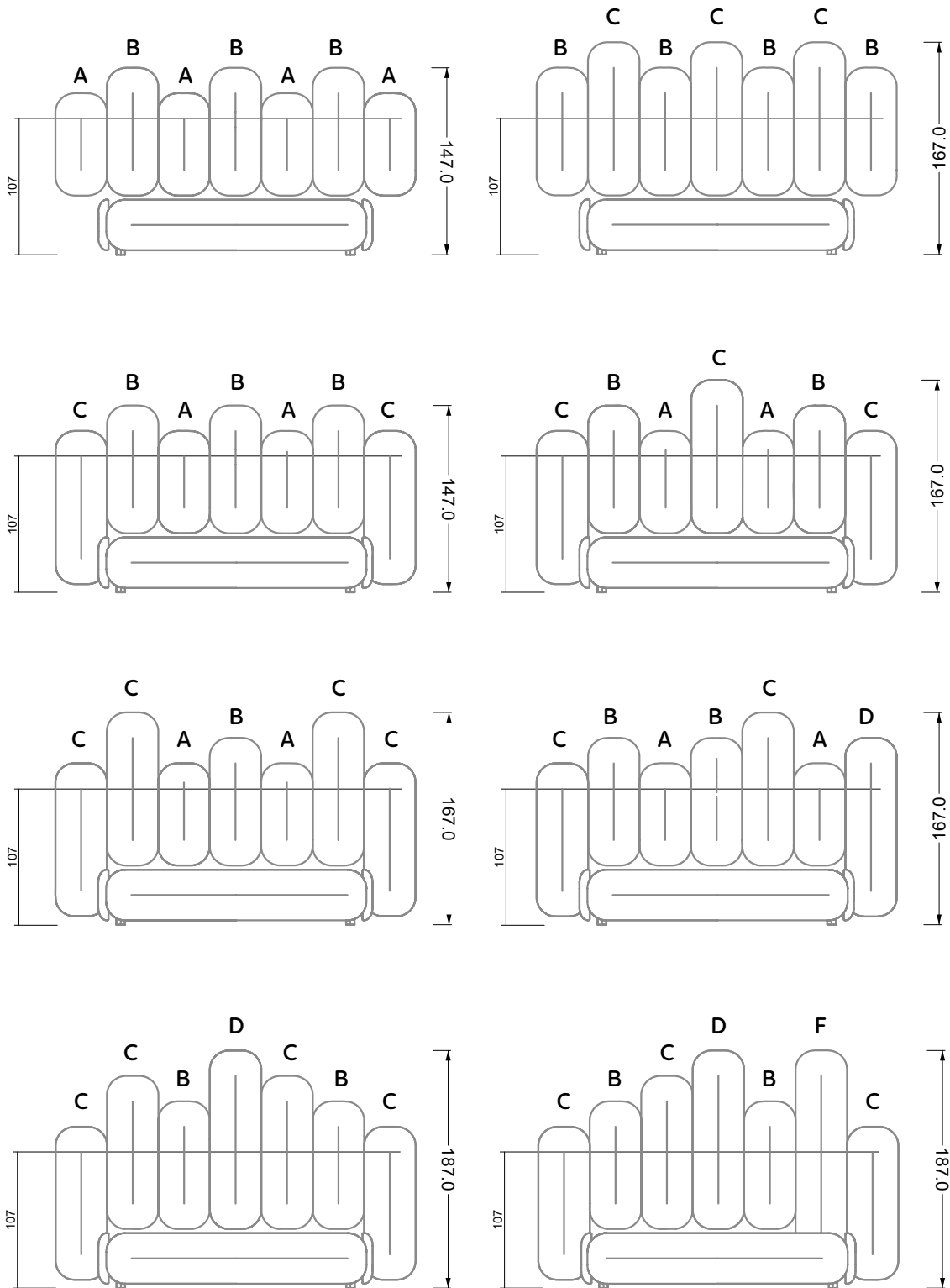

W 129-200

8-er

Breite: 324,0 cm

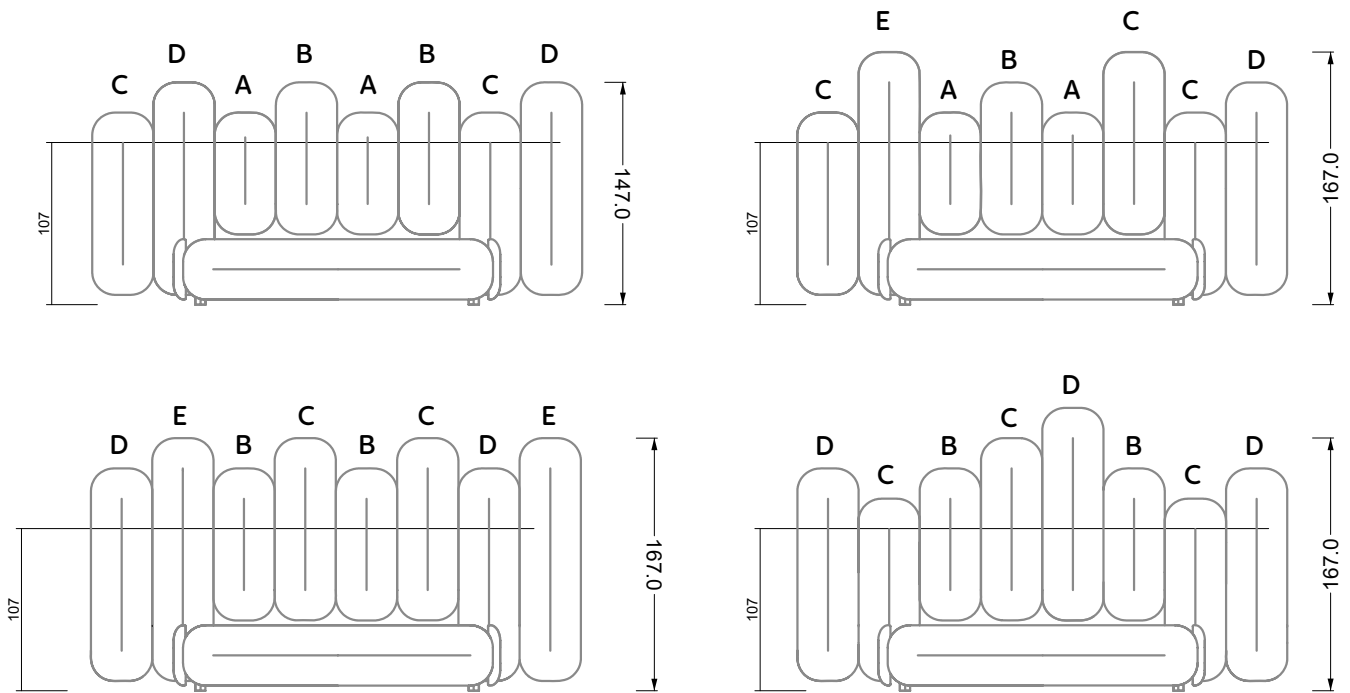

9-er

Breite: 364,5 cm

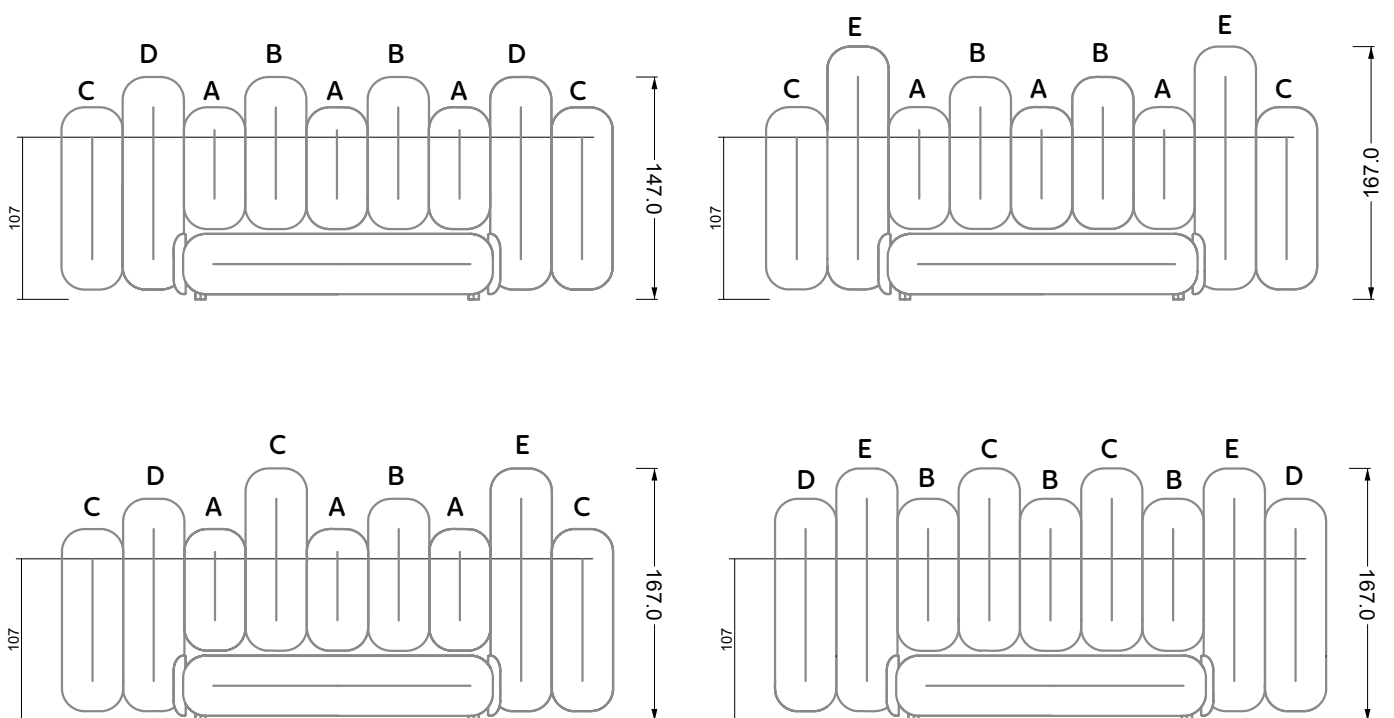

W 129-200

5-er

Breite: 202,5 cm

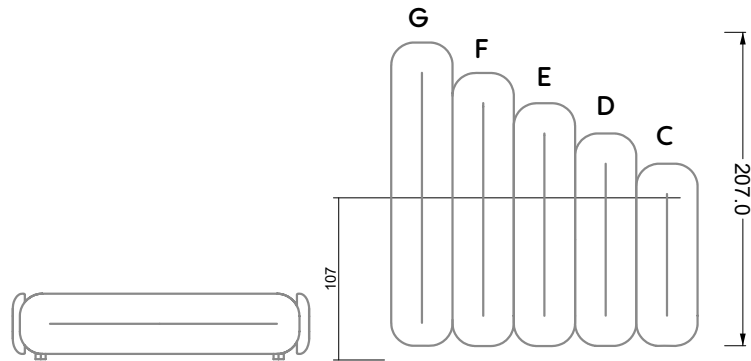
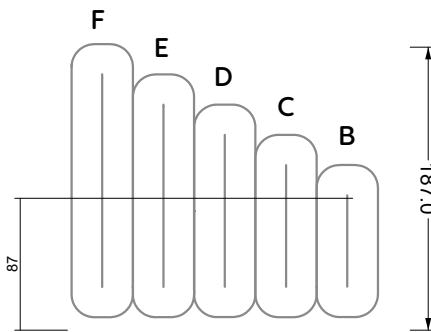
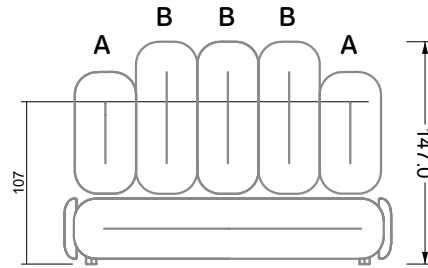
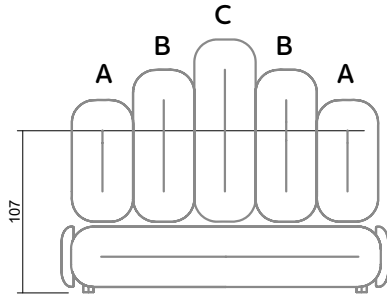

6-er

Breite: 243,0 cm

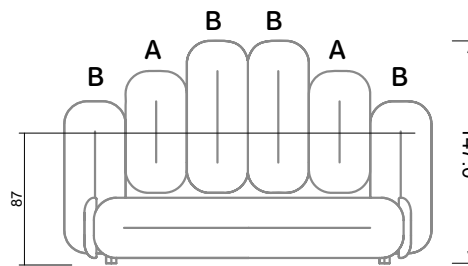
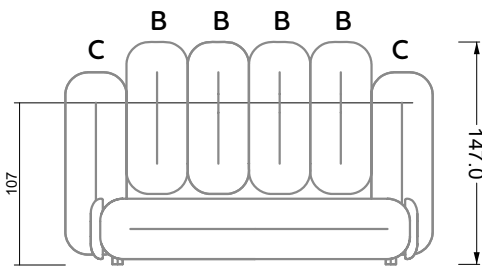

SET 2.1

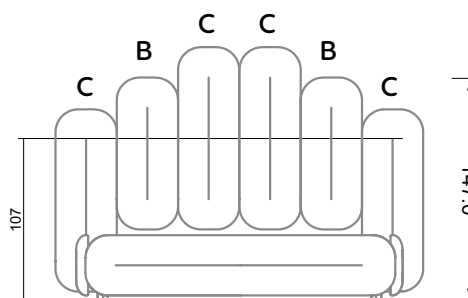
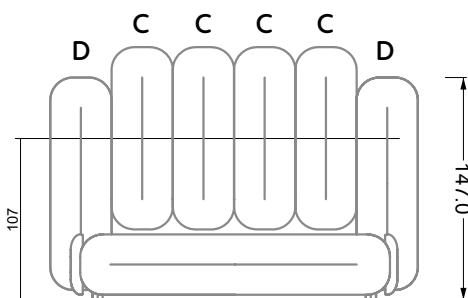

W 129-200

7-er

Breite: 283,5 cm

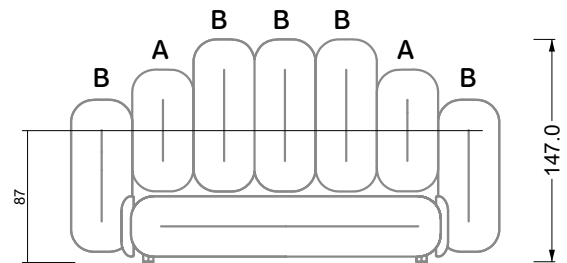
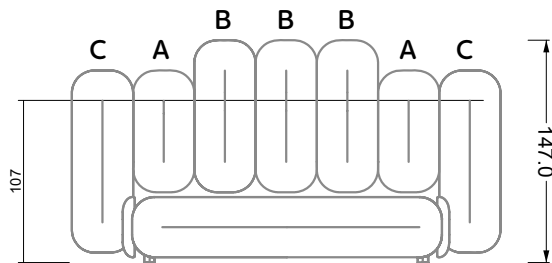

8-er

Breite: 324,0 cm

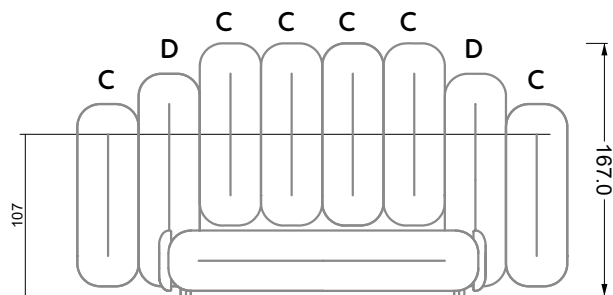
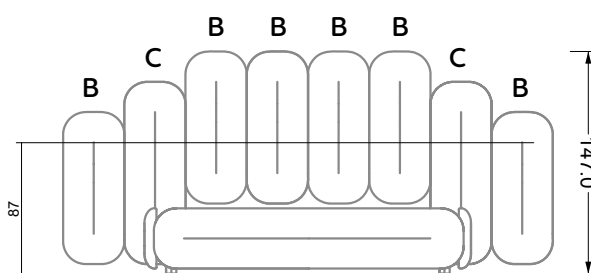
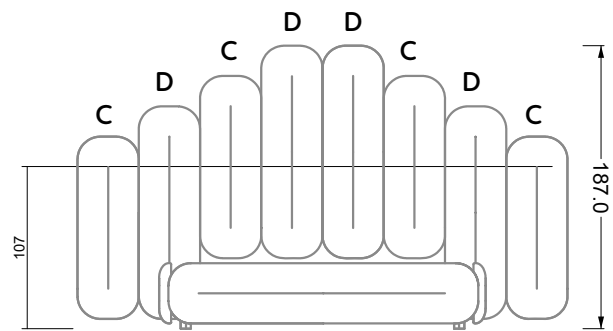
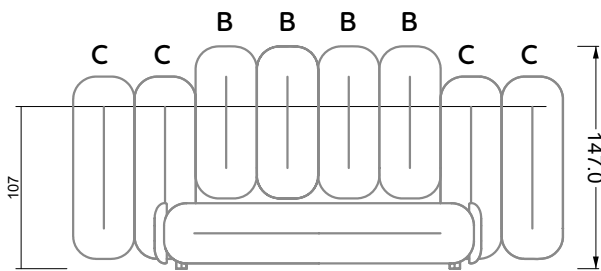

9-er

Breite: 364,5 cm

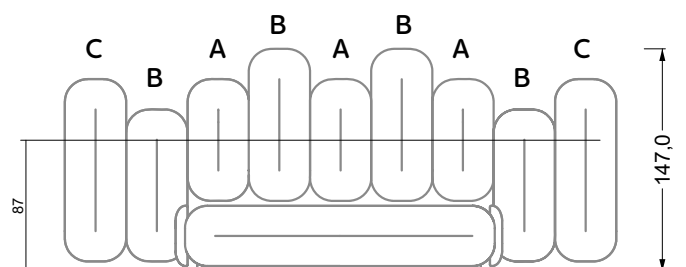
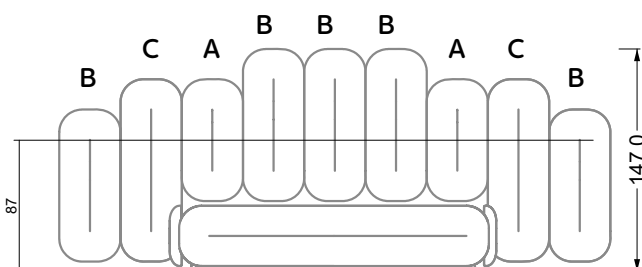

Bettssystem Creole

Unsere Polsterbetten setzen in Design- und Verarbeitungsqualität weltweit Maßstäbe. Damit aber nicht genug: Wie unsere Sofas und Sessel, muss das in unseren Betten integrierte Schlafsystem höchsten ergonomischen Maßstäben genügen. Denn nur wenn Matratze und Unterfederungen ideal zueinander passen, können sich Körper und Geist beim Schlafen so richtig entspannen und regenerieren: Unsere Matratzen und Unterfederungen ermöglichen, dass die Wirbelsäule die ihr von Natur aus gegebene, entspannte Form einnehmen kann, nämlich 1. Von der Seite gesehen die ihr eigene Doppel-S-Form (besonders wichtig für Rückenschläfer) und 2. von hinten gesehen eine gerade Linie, frei von seitlichen Verformungen (besonders wichtig für Seitenschläfer). Bei Seitenschläfern können Schulter und Becken idealerweise so tief in die Matratze einsinken, dass die dargestellte gerade Linie von alleine entsteht. Allgemein gilt: eine perfekte Kombination aus Matratze und Unterfederung fördert ein rückengerechtes Einsinken, stützt den Körper jedoch dort, wo es notwendig ist. So können Steißbein, Kreuzbein sowie Lenden-, Brust- und Halswirbelsäule sich während des Schlafs in vollkommener Harmonie regenerieren.

Hochwertiges Kaltschaum-Schlafsystem

Kombination für Rückenschläfer, die ein Schlafgefühl mit mittlerem Härtegrad bevorzugen:

Kaltschaum-Matratze M 155S + Federholzrahmen L 155S.

Punktelastische Matratze, mit hohem Raumgewicht von 50kg/m³. Hohe Atmungsaktivität.

Bretz Kaltschaum-Matratze:

Stauchhärte: Mittel / fest (37 kPa), hohes Raumgewicht (50 kg/cbm), punktlastisch. Von Kaltschaum spricht man, wenn der Schäumungsprozess mit besonderen Rezepturen ohne Wärmezufuhr vollzogen wird. Die offene Zellstruktur führt zu hoher Atmungsaktivität, perfekter Durchlüftung sowie Wärme- und Feuchtigkeitsausgleich. Körpergerechte Einschnitte an der Oberfläche teilen die Matratze in sieben Körperzonen ein. Matratzenbezug aus Nicky-Velours: Eigenschaften wie Boxspring-System-Matratze.

Bretz Federholzrahmen:

Schichtholzrahmen mit holmüberdeckenden Buchen-Federholz-leisten, die auf hochelastischen, nach allen Seiten beweglichen Gummi-Elementen lagern. Dadurch optimale Federelastizität über die gesamte Liegefläche, auch an den Rändern. 7 Liege-Zonen mit körpergerechter Elastizitäten-Verteilung. Härteverstellsschieber im Lenden- und Beckenbereich sorgen für eine individuelle Anpassung an Körpergewicht und Körpergröße. Perfekt für Körpergewichte bis 110 kg.

Tiefe 200 cm / Höhe 19 cm
Breite 160 cm / 180 cm / 200 cm

Tiefe 198 cm / Höhe 7,5 cm
Breite 79 cm / 89 cm / 99 cm

Rückenschläfer: Mittelfeste Unterstützung der „Doppel-S“-geformten Wirbelsäule

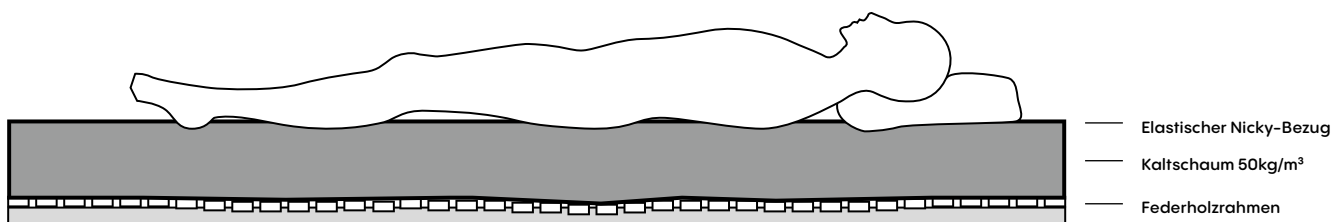

Königliches Boxspring- Matratzen- system

Das Königliche, samtig-anschmiegsame Spitzenprodukt aus dem Hause Bretz ist für höchste anatomische Ansprüche entwickelt. Der **120 mm hohe Taschenfederkern enthält mehr als 500 Federn pro m²** in einzelne Taschen eingebettete, thermisch vergütete 7,5 Gang-Stahl-Federn mit einem Durchmesser von jeweils 42 mm und einer Drahtstärke von 1,4/1,3 mm, über die Liegefläche **auf 7 Zonen verteilt**. So können Becken und Schultern anatomisch richtig in die Matratze einsinken, andere Körperzonen wie die Lendenwirbelsäule werden stabilisierend unterstützt – die Wirbelsäule bleibt über die ganze Länge frei von seitlichen Verformungen. Die nur 42 mm breiten Federtaschen sind durch einen mittig angebrachten Textilsteg miteinander verbunden. Der Druck auf eine kleine Fläche wird so direkt aufgenommen (einzelne Federn geben nach) und nicht auf eine große Fläche übertragen, d.h. unsere Boxspring-Systemmatratze bietet eine **ausgezeichnete Punktelastizität**. Auch empfindliche Körperzonen werden so optimal gestützt. Die Wirbelsäule kann in jeder Position eine entspannte Haltung einnehmen. Eine 85 mm hohe Höchstleistungskaltschaumabdeckung, mit **extrem hohem Raumgewicht 70 (!) kg/cbm**, Stauchhärte 24 kPa = königlich soft, bringt die Qualitäten unserer **Boxspringsystem-Matratze** zur Vollendung: optimale Schultern- und Beckenentlastung bei gleichzeitig

Enorm hoher Rückstellkraft, Punkt- und Dauerelastizität (erst einmalig soft, dann wird angenehmer Gegendruck aufgebaut). Menschen mit einem Körpergewicht bis etwa 100kg können ein einmalig anschmiegsames Schlaferlebnis genießen, mit optimaler Entlastung im Schulter- und Beckenbereich. Die offene Porenstruktur ermöglicht eine perfekte Durchlüftung und einen sehr guten Wärme-/Feuchtigkeitsausgleich. Der sehr **punktelastische Nicky-Velours-Matratzenbezug** (350g /m², 75% CO₂ 5% PES, Farbe: roh gewaschen) ist versteppt mit PES-Hohlfaser (200g/m²) und sorgt aufgrund seiner offenen Gewebeschlingen (große Oberfläche!) für perfekte Feuchtigkeitsaufnahme auch -abgabe und damit für ein optimales Matratzenklima. Die obere Hälfte des Matratzenbezugs (mit **Rundum-Reißverschluss**) ist abziehbar, bei 60 Grad waschbar oder reinigbar. Die **Bretz-Boxspring-System-Untermatratze** ist die optimale Ergänzung unserer Bretz Boxspring-System-Matratze. Sie wird wie ein Lattenrost in den Bettrahmen eingelegt („Boxspring inside“). Aufbau: Holzplatte mit Lüftungsöffnungen, darüber 6 cm hoher Taschenfederkern, der die Elastizität der Obermatratze optimal unterstützt. Atmungsaktiver Bezug für perfekten Wärme- und Feuchtigkeitsaustausch. Ist eine niedrigere Einlegehöhe gewünscht, kann auch der **Bretz Federholzrahmen** als Unterfederung verwendet werden.

Matratzentiefe 200 cm / -Höhe 28 cm
-Breite 160 cm / 180 cm / 200 cm

Untermatratzentiefe 198 cm / -Höhe 11 cm
-Breite 79 cm / 89 cm / 99 cm

Rückenschläfer: Sanfte Unterstützung der „Doppel-S“-geformten Wirbelsäule, hohe Anfangsweiche

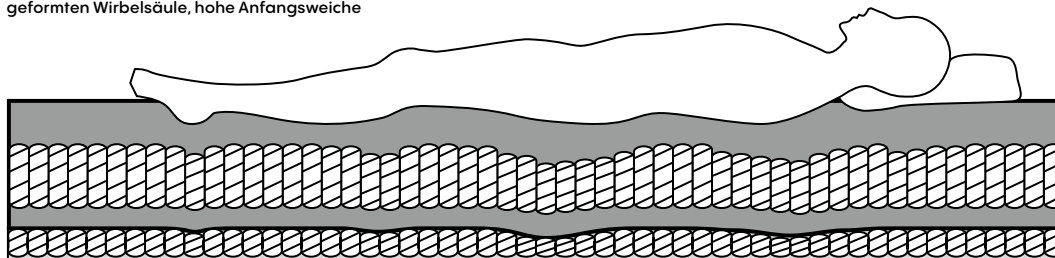

- Elastischer Nicky-Bezug
- Kaltschaum 70kg/m³
- 1800/1575/1395 Taschenfedern
- Fester Schaum
- Taschenfederkern

Seitenschläfer: Optimale Becken- und Schulterentlastung durch weichere Federung in diesem Bereichen.

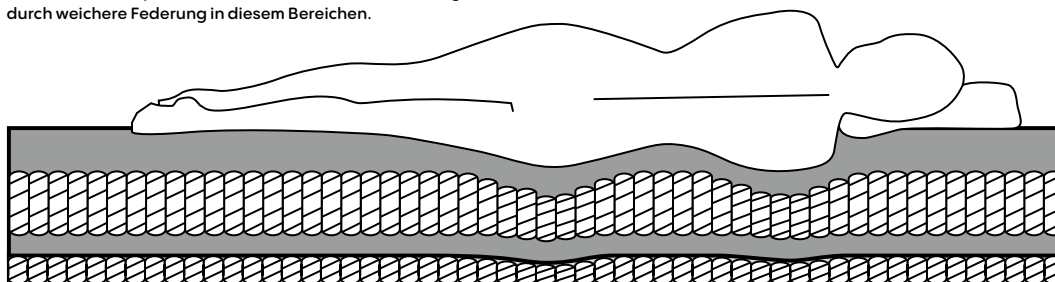

- Elastischer Nicky-Bezug
- Kaltschaum 70kg/m³
- 1800/1575/1395 Taschenfedern
- Fester Schaum
- Taschenfederkern

Bed Creole

Bretz upholstered beds have evolved into worldwide benchmarks for design and for the quality of workmanship. Not good enough for us: following the example of Bretz sofas and chairs, our sleeping systems must comply to highest standards of contemporary ergonomics. Only a perfect match of mattress and underlay/frame will allow body and mind to relax and regenerate soundly while sleeping. As perfectly regenerating sleeping system components, our mattresses and bases allow the human spinal column to adopt its unstressed, original shape given to it by mother nature: 1. its unique double-S-shape (seen from the side; eminently important for "back sleepers") and 2. its straight line, without lateral distortion (seen from behind; eminently important for "side sleepers"). Side sleepers thrive on mattresses that allow the shoulder to sink in as deeply as needed in order to let the straight line described above emerge on its own. Generally spoken: pelvis, lumbar, thoracic and cervical spine regionals may regenerate in total harmony while sleeping. The perfect match of mattress and base will allow the body to sink in ergonomically while firming it up where needed.

Value sleeping system

for back sleepers preferring to sleep on a medium degree of hardness:

Cold foam mattress M 155S + slatted frame L155S.

Elastic mattress, with high volumetric weight of 50 kg/cbm. Highly breathable.

Bretz cold foam mattress:

foam rigidity: medium/solid (37 kPa), high volumetric weight (50 kg/cbm), good spot elasticity. "Cold foams" are produced with special formulations, without the addition of heat. The open pore structure is highly breathable and provides a perfect balance of temperature and humidity. Carefully positioned cuts on its surface divide the mattress into seven body zones. Mattress cover and widths: like Box-spring System Mattress.

Bretz slatted frames:

wooden frames with plywood slats (beech). Borders resting on elastic gum elements, thus ideal spring elasticity across the whole lying space, even at the edges. 7 lying zones with elasticity distribution following body needs. Adjustments in lumbar and pelvis area provide individual adaption to body weight and height. Ideal for weights up to 110kg.

length 200 cm / height 19 cm
widths 160 cm / 180 cm / 200 cm

length 198 cm / height 7,5 cm
widths 79 cm / 89 cm / 99 cm

Back sleepers: solid support of „double-s“ formed spine

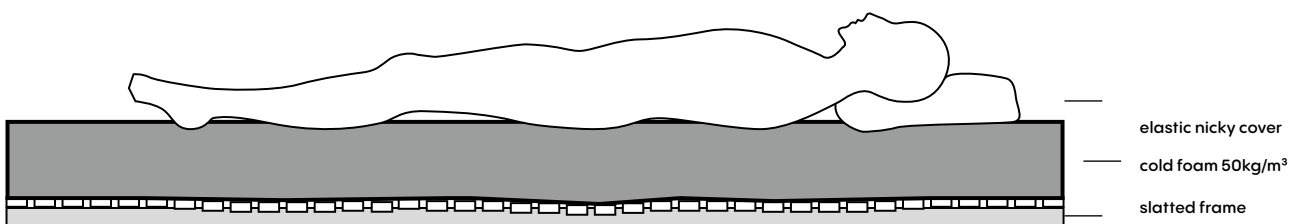

Royal Boxspring- mattress- system

Royal & supple top quality product by Bretz - designed for highest anatomical requirements. The **120 mm high pocket spring core** contains – depending on mattress width – 1800/1575/1395 thermically enhanced 7,5 gear steel feathers with a diameter of 1,4/1,3m, bedded in individual pockets, **divided into 7 sleeping zones** across the lying space. This way pelvis and shoulders can sink into the mattress in an anatomically correct way. Other body parts, eg. the lumbar spine are stabilized – the spine is free of lateral deformations. The 42mm wide feather pockets are connected by a textile string. Pressure on a small space will be absorbed immediately (individual feathers backing down) – which means our BOXSPRING SYSTEM MATTRESS offers an **excellent spot elasticity**. Sensitive body parts will be ideally protected. The spine can always get into a relaxed position. A 85 mm high performance cold foam overlay – **extremely high volumetric weight of 70(!) kg/cbm**, low foam rigidity of 24kPa (!) = absolutely royally soft – makes our Boxspring System Mattress perfect: ideal shoulder and pelvis relief, with spot elasticity and permanence at their extremes. This mattress is soft at first, then a comfortable, pro-

gressive counter pressure develops. Thus, even tall people with a weight of up to 100kg may enjoy a unique cuddly sleeping experience, with an optimal relief of their shoulders and pelvis. The open pore structure gives you a perfect aeration with a very good balance of temperature and humidity. Removable mattress cover: **very spot elastic nicky velours** (350g/m², 75% CO, 25% PES, color: “washed” greige), quilted with PES hollow fibres (200g/m²). Entertains an ideal mattress climate. With quilted Bretz Logos. **All around zip**, washable at 60 degrees.

Bretz Boxspring System Base: ideal complement for your Bretz Boxspring System Mattress. To be put into the frame like a slatted frame base (“boxspring inside”). Wooden board with aeration holes, above: 6cm high pocket feather core that supports the elasticity of the overlying mattress. Breathable cover for perfect balance of temperature and humidity. Boxspring mattress are also available in combination with slatted frame bases. (4 cm lower, thus perfectly suitable for Cloud7 beds)

Matress length 200 cm / height 28 cm
widths 160 cm / 180 cm / 200 cm

Base length 198 cm / height 11 cm
widths 79 cm / 89 cm / 99 cm

Back sleepers: Supple support of the „double-S“ form of the spine, royal softness

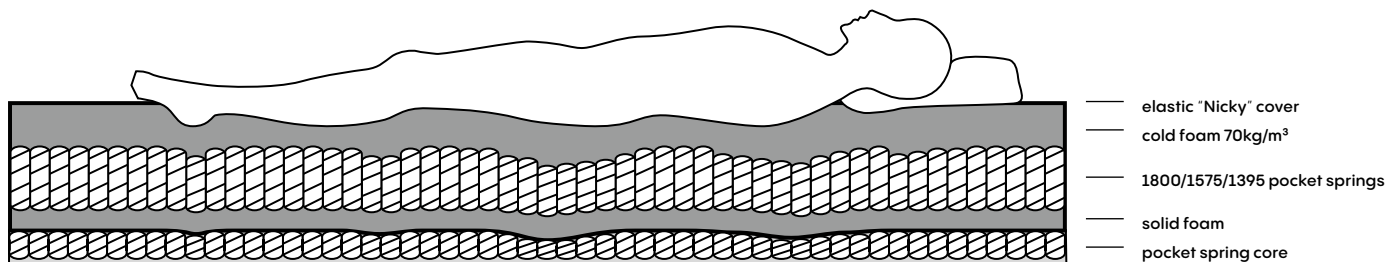

Side sleepers: Ideal pelvis and should relief with supple suspension in these areas

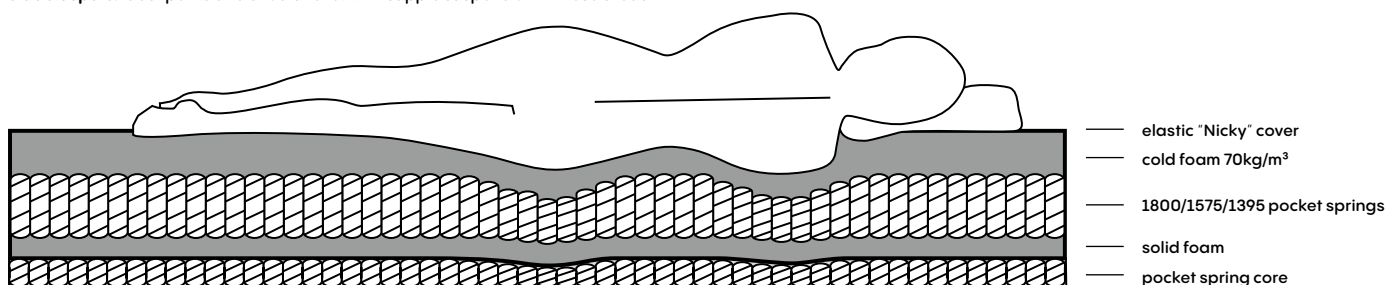

Lit Creole

nos lits établissent de nouveaux critères quant à la qualité de design et de la finition. Comme pour nos canapés et fauteuils, le système somnifère intégré dans nos lits, doit répondre aux plus hauts critères ergonomiques. En effet, seulement quand matelas et sommiers conviennent idéalement l'un à l'autre, corps et esprit peuvent se détendre et se régénérer. Nos matelas et sommiers permettent que la colonne vertébrale prenne sa forme relaxée qui lui a été donnée par la nature, à savoir 1. Vu de côté, sa propre forme de double S (important pour le dormeur dorsal) et 2. Vu de derrière, une ligne droite sans déformation latérale (important pour le dormeur latéral). Pour le dormeur latéral, l'épaule peut idéalement s'enfoncer dans le matelas jusqu'à ce que la ligne droite représentée se forme toute seule. En général est valable: une combinaison parfaite entre matelas et sommier aide le dos à s'enfoncer correctement mais appuie le corps là où c'est nécessaire. Ainsi que les vertèbres lombaires, pectorales et cervicales peuvent se régénérer en parfaite harmonie lors du sommeil.

Mousse froide de haute qualité

combinaison pour dormeur dorsal qui préfère un matelas de qualité avec une fermeté moyenne :

Matelas mousse froide M 155S + sommier à lattes L 155S.

Matelas avec bonne élasticité ponctuelle, et haut poids spatial de 50 kg/cbm. Bonne activité de respiration.

Bretz matelas en mousse froide :

Degré de fermeté moyenne (37 kPa), haut poids spatial (50 kg/cbm), élasticité de point. On parle de mousse froide lorsque la production est faite avec des compositions spéciales sans alimentation thermique. La structure ouverte des cellules occasionne une haute activité respiratoire, une parfaite aération ainsi qu'une compensation de chaleur et d'humidité. Adapté au corps, des incisions à la surface du matelas le divisent en 7 zones corporelles. Tissu du matelas et largeur : comme système de matelas BOXSPRING.

Sommier a lattes et matelas :

un cadre en bois empilé de liteaux en bois d'hêtre recouvrant les barres. Ces liteaux reposent sur des éléments en caoutchouc très élastiques et mobiles dans tous les sens. Ainsi on reçoit une élasticité optimale sur la surface entière, même sur les bords. 7 zones de couchage avec une répartition de l'élasticité adaptée au corps. Au niveau du pelvis et des lombes, la dureté est réglable en continu grâce à un curseur de renforcement ajustable. Convient à des poids jusqu'à 110 kg.

P 200 cm / H 19 cm
L 160 cm / 180 cm / 200 cm

P 198 cm / H 7,5 cm
L 79 cm / 89 cm / 99 cm

Dormeur dorsal : un soutien ferme moyen „double-S“ de la colonne vertébrale

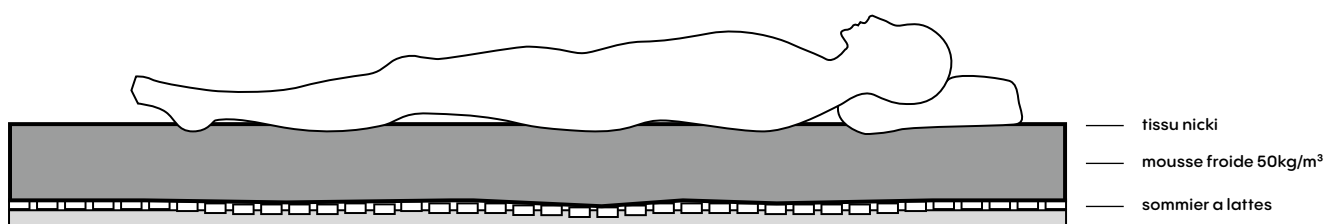

Royal boxspring- systeme- matelas

Royal, souple, un produit de qualité de la maison BRETZ – conçu pour les revendications anatomiques élevées. Le **coeur à ressorts empochés de 120 mm de haut** contient **> 500 (!) ressorts par m²** chacun enveloppé dans une poche textile. Les coordonnées techniques de ces ressorts: acier thermiquement affiné, 7,5 rotations, diamètre de 42 mm, épaisseur du fil de 1,3 ou 1,4 mm, **repartis sur 7 zones** de couchage. Le bassin et les épaules peuvent donc sombrer dans le matelas tout en gardant l'anatomie correcte de sommeil, d'autres parties du corps tel que le rachis lombaire seront favorablement soutenus – la colonne vertébrale reste libre d'une déformation latérale sur toute sa longueur. Les poches des ressorts – seulement 42 mm de larges – sont reliés au centre vertical par une bande textile. La pression sur une petite surface sera directement absorbée (chaque ressort individuel cède de façon autonome) et ne se transmet pas à une grande surface. C'est pourquoi notre Boxspring-systeme matelas offre une **excellente élasticité ponctuelle**. Les zones particulièrement sensibles du corps sont soutenues de façon optimale. La colonne vertébrale peut assumer une posture détendue dans une position quelconque. Une mousse froide de 85 mm de haut – une **densité extrême de 70 (!) kg/cbm**, degré de fermeté très basse de 24 kPa = « doux royal » – apporte une finalisation de qualité de nos Boxspring-systeme matelas : un soulagement optimal pour les

épaules et le bassin, une **élasticité permanente** (douce en 1er – ensuite une contre pression agréable se développe). Même les personnes de grande taille avec un poids jusqu'à environ 100kg peuvent profiter d'un sommeil unique et souple avec un soulagement optimal dans la zone de l'épaule et du bassin. Une circulation d'air optimale en raison de la structure de pores et un très bon équilibre d'humidité et de chaleur. Housse de matelas amovible: **super élastique nicki velours** (350 g/m², 75%CO, 25%PES, coloris : lavé brut, piquée avec PSE une fibre climatique (200 g/m²). En raison de son tissage (les boucles du nicky agrandissent sa surface énormément), le nicky assure une absorption d'humidité parfaite et un climat de matelas optimal. Avec un logo Bretz matelassé. **Fermeture-éclairé tout autour** ; la partie de haut est déhoussable et lavable à 60 degré et nettoyable.

Bretz boxspring-systeme-sous matelas : complément optimal de notre Bretz boxspring-systeme-matelas. Il s'insère dans le cadre comme les sommiers à lattes (« Boxspring inside »). Panneau de bois avec des ouvertures d'air, dessus un ressort ensaché de 6 cm de haut, un soutien optimal d'élasticité du matelas. Tissu respirant pour une parfaite échange de chaleur/ d'humidité.

matelas longueur 200 cm / hauteur 28 cm
largeurs 160 cm / 180 cm / 200 cm

sous-matelas longueur 198 cm / hauteur 11 cm
largeurs 79 cm / 89 cm / 99 cm

Dormeur dorsal : souple soutien « double-s » de la colonne vertébrale

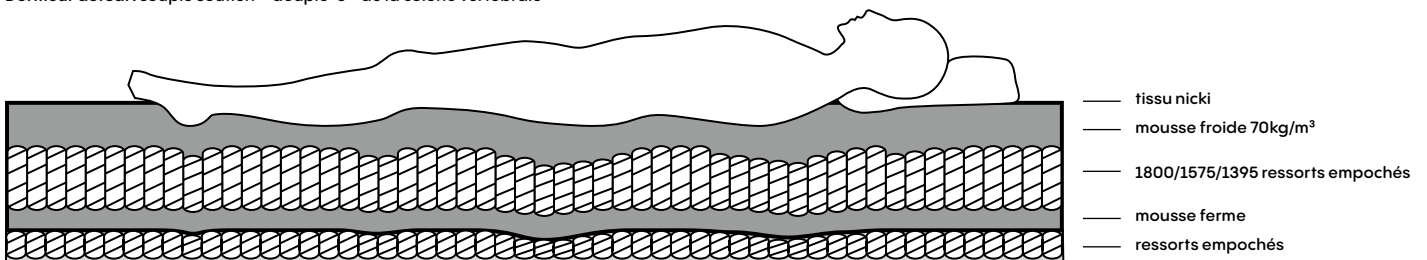

Dormeur latéral : soulage optimal du bassin et de l'épaule.

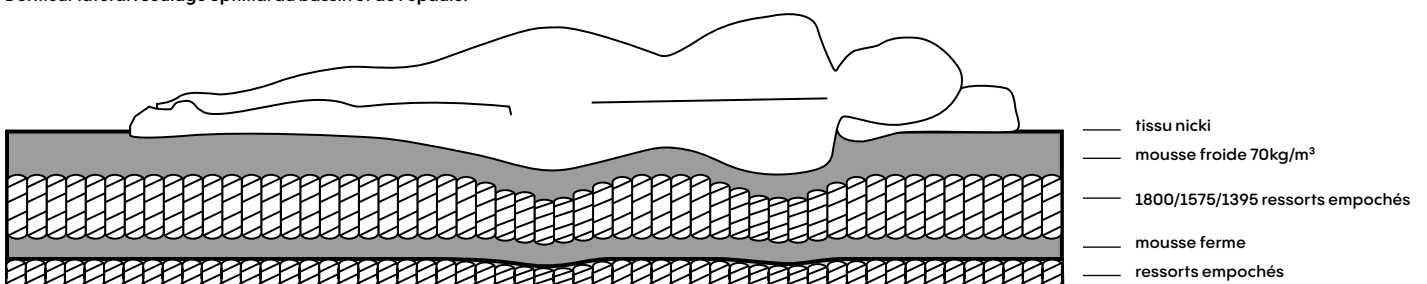

Bretz
German Manufacture
Since 1895

Head Office & Showroom:

Alexander-Bretz-Str. 2
D-55457 Gensingen
Tel +496727-895-0
E-Mail info@bretz.de

Bretz Sales Flagships & Partners:
bretz.de

f BretzSofas
@bretz_sofas

Bretz
True Characters